



CDM
n=2900rpm

Многоступенчатый насос из нержавеющей стали AISI 304

ОПИСАНИЕ

- ♦ Вертикальный многоступенчатый центробежный насос SS304.
- ♦ Круглый фланец, вход и выход на одной оси
- ♦ Основание насоса CDM изготовлены из чугуна.
- ♦ Рабочее колесо и вал CDM изготовлены из нержавеющей стали.
- ♦ Все проточные детали CDMF изготовлены из нержавеющей стали.
- ♦ Высокоэффективный двигатель YE3 с классом защиты IP55 F.
- ♦ Износостойкое механическое уплотнение.
- ♦ Температура жидкости от -10°C до +120°C.

ПРИЛОЖЕНИЯ

Многоступенчатые насосы подходят для промышленных систем обработки, системы мойки и очистки, перекачки кислоты и щелочи, системы фильтрации, повышение давления воды, ирригация и т. д.

КОД МОДЕЛИ

CDM(F) 15 - 9

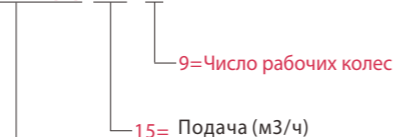

CDM= Вертикальный многоступенчатый насос

CDMF= Насос с компонентами проточной части из AISI 304



ТЕХНИЧЕСКИЕ ДАННЫЕ 50Hz 2900 об/мин

МОДЕЛЬ	DN	Мощность		Q=Подача																
				GPM 0	2.2	3.1	4.4	5.3	6.2	7.0	7.9	8.8	9.7	10.6	12.3	13.2	14.1	15.9	17.6	19.4
				l/min 0	8.3	11.7	16.7	20	23.3	26.7	30	33.3	36.7	40	46.7	50	53.3	60	66.7	73.3
				N=Общий напор в метрах водяного столба (м)																
				m³/h 0	0.5	0.7	1	1.2	1.4	1.6	1.8	2	2.2	2.4	2.8	3	3.2	3.6	4	4.4
CDM 1-2	25x25	0.37	0.5	11.8	11.5	11.2	10.5	10.3	9.7	9	8	6.8	5.5	4	-	-	-	-	-	-
CDM 1-3	25x25	0.37	0.5	17.5	17	16.8	16	15.6	14.8	13.5	12	10	8.5	6	-	-	-	-	-	-
CDM 1-4	25x25	0.37	0.5	23.5	23	22.5	21.5	21	19.8	18	16	13.5	11	8	-	-	-	-	-	-
CDM 1-5	25x25	0.37	0.5	29	28.5	28	27	26	24.5	22.5	20	17	14	10	-	-	-	-	-	-
CDM 1-6	25x25	0.37	0.5	35	34.5	34	32.5	31.5	30	27	24	20.5	17	12.5	-	-	-	-	-	-
CDM 1-7	25x25	0.37	0.5	41	40.5	40	39	37	35	32	28	24	20	15	-	-	-	-	-	-
CDM 1-8	25x25	0.55	0.75	47	46	45.5	43.5	42	40	37	33	29	24.5	18	-	-	-	-	-	-
CDM 1-9	25x25	0.55	0.75	52.5	52	51.5	49	47	44.5	41	37	32	27	20.5	-	-	-	-	-	-
CDM 1-10	25x25	0.55	0.75	58.5	58	57	55	52.5	50	46	42	37	31	23	-	-	-	-	-	-
CDM 1-11	25x25	0.55	0.75	64	63.5	63	61	58.5	55	51	46	40	33.5	25.5	-	-	-	-	-	-
CDM 1-12	25x25	0.75	1	70	69	68.5	67	64.5	61	57	52	45.5	37	28	-	-	-	-	-	-
CDM 1-13	25x25	0.75	1	75.5	75	74.5	73	70	66.5	61.5	56	49	40.5	31	-	-	-	-	-	-
CDM 1-15	25x25	0.75	1	87.5	86.5	85.5	84	81	76.5	71	65	57	47	36	-	-	-	-	-	-
CDM 1-17	25x25	1.1	1.5	99	98	97	95	91.5	86.5	81	73	64	53	41	-	-	-	-	-	-
CDM 1-19	25x25	1.1	1.5	110	109	108	106	103	98	91	82	72	59	46	-	-	-	-	-	-
CDM 1-21	25x25	1.1	1.5	122	121	120	117	113	107	100	90	78	65	50	-	-	-	-	-	-
CDM 1-22	25x25	1.1	1.5	128	127	126	122	118	112	105	95	83	69	54	-	-	-	-	-	-
CDM 1-23	25x25	1.5	2	134	133	132	128	123	118	111	102	90.5	76.5	58	-	-	-	-	-	-
CDM 1-25	25x25	1.5	2	146	145	144	139	134	128	121	111	98	83	63	-	-	-	-	-	-
CDM 1-27	25x25	1.5	2	158	157	155	150	145	138	130	119	106	90	69	-	-	-	-	-	-
CDM 1-30	25x25	1.5	2	175	174	172	167	161	154	145	133	118	100	77	-	-	-	-	-	-
CDM 1-32	25x25	2.2	3	189	188	186	180	174	166	155	143	129	110	85	-	-	-	-	-	-
CDM 1-33	25x25	2.2	3	195	194	192	186	180	171	160	148	133	113	87	-	-	-	-	-	-
CDM 1-34	25x25	2.2	3	200	199	198	192	185	176	165	152	137	117	90	-	-	-	-	-	-
CDM 1-36	25x25	2.2	3	212	211	209	203	196	186	175	161	145	124	95	-	-	-	-	-	-
CDM 1-38	25x25	2.2	3	225	224	221	215	208	197	185	171	153	131	101	-	-	-	-	-	-
CDM 1-40	25x25	2.2	3	237	236	233	226	219	208	195	180	161	138	106	-	-	-	-	-	-
CDM 3-2	25x25	0.37	0.5	14.7	-	-	-	14	14	13.5	13	13	13	12.5	11.5	11	10.5	9.5	8	6
CDM 3-3	25x25	0.37	0.5	22.2	-	-	-	21.5	21	21	21	20.5	20	19.5	18	17	16.5	15	12.5	9.5
CDM 3-4	25x25	0.37	0.5	29.7	-	-	-	29	29	28.5	28	27.5	27	26	24	23	22	20	17	13
CDM 3-5	25x25	0.55	0.75	37.2	-	-	-	36	36	35	34	33.5	33	32	30	29	28	25	21	16
CDM 3-6	25x25	0.55	0.75	45	-	-	-	43.5	43	42.5	42	41	40	39	36.5	35	33.5	30	25	19.5
CDM 3-7	25x25	0.75	1	52.5	-	-	-	51	51	50	50	49	48	46	43	41	39.5	35	30	23
CDM 3-8	25x25	0.75	1	60	-	-	-	58.5	58	58	57	56	55	53	49	47	45	40	34	26.5
CDM 3-9	25x25	1.1	1.5	67.5	-	-	-	66	66	65	64	63	62	60	56	53	51	45	38	30
CDM 3-10	25x25	1.1	1.5	75	-	-	-	73	73	72	71	70	68	66	61	59	56	50	42	33.5
CDM 3-11	25x25	1.1	1.5	82.5	-	-	-	80	80	79	78	77	75	73	68	65	62	55	47	37
CDM 3-12	25x25	1.1	1.5	90	-	-	-	88	87	86	85	83	81	79	74	71	67	59	50	40.5
CDM 3-13	25x25	1.5	2	98	-	-	-	95	94	93	92	90	88	86	80	77	73	64	54	44
CDM 3-14	25x25	1.5	2	105	-	-	-	102	102	101	100	98	95	92.5	86	83	78	69	58	47
CDM 3-15	25x25	1.5	2	113	-	-	-	110	109	108	107	105	103	100	94	90	86	76	64	51
CDM 3-16	25x25	1.5	2	120	-	-	-	118	117	116	114	112	110	107	100	96	92	81	69	54
CDM 3-18	25x25	2.2	3	136	-	-	-	133	132	130	128	126	123	120	113	108	102	90	76	61
CDM 3-19	25x25	2.2	3	143	-	-	-	140	139	137	135	132	129	126	119	114	108	96	82	64
CDM 3-20	25x25	2.2	3	151	-	-	-	148	146	144	142	140	137	133	125	120	114	100	85	67
CDM 3-21	25x25	2.2	3	158	-	-	-	155	154	152	150	147	144	140	131	126	120	106	90	71
CDM 3-22	25x25	2.2	3	166	-	-	-	162	160	158	156	154	150	146	137	132	125	110	93	74
CDM 3-23	25x25	2.2	3	173	-	-	-	170	168	166	164	161	157	153	144	138	131	115	97	78
CDM 3-24	25x25	2.2	3	181	-	-	-	177	175	173	171	168	164	160	150	144	137	120	101	81
CDM 3-25	25x25	3	4	188	-	-	-	185	183	181	178	175	171	166	156	150	142	125	105	85
CDM 3-27	25x25	3	4	204	-	-	-	200	198	195	192	188	184	180	169	162	155	138	117	92
CDM 3-28	25x25	3	4	212	-	-	-	207	205	202	199	195	191	187	175	168	160	143	121	95
CDM 3-29	25x25	3	4	220	-	-	-	215	213	210	207	203	199	194	182	175	167	148	126	99
CDM 3-31	25x25	3	4	235	-	-	-	230	227	224	220	216	212	207	194	187	178	159	134	106

ТЕХНИЧЕСКИЕ ДАННЫЕ

50Hz n=2900 об/мин

МОДЕЛЬ	DN	Мощность		Q=Подача												
				GPM 0	11	13	18	22	26	31	35	37	44	53	62	
		l/min 0	42	50	67	83	100	117	133	142	167	200	233			
		m³/h 0	2.5	3	4	5	6	7	8	8.5	10	12	14			
mm		kw	hp	H=Общий напор в метрах водяного столба (м)												
CDM 5-2	32x32	0.37	0.5	14.7	13.5	13.3	12.5	11.5	9	7	5	4	-	-	-	
CDM 5-3	32x32	0.55	0.75	22.1	21	20.5	19	17.5	15	12	9	7.5	-	-	-	
CDM 5-4	32x32	0.55	0.75	29.5	28	27.5	26	24	21	17	13	11	-	-	-	
CDM 5-5	32x32	0.75	1	37	35	34.5	33	30	27	23	18	15	-	-	-	
CDM 5-6	32x32	1.1	1.5	44.5	42	41.5	40	37	33	27	21	18	-	-	-	
CDM 5-7	32x32	1.1	1.5	52	49.5	48.5	46	42.5	38.5	31.5	24.5	21	-	-	-	
CDM 5-8	32x32	1.1	1.5	59	57	56	53	49	44	36	28	24	-	-	-	
CDM 5-9	32x32	1.5	2	67	64	63	60	55	49.5	41.5	31.5	27	-	-	-	
CDM 5-10	32x32	1.5	2	74.5	71	70	66	62	55	46	35	30	-	-	-	
CDM 5-11	32x32	1.5	2	82	78	77	73	68	61	51	39	33	-	-	-	
CDM 5-12	32x32	2.2	3	89.5	85	84	81	74.5	66	55	43	37	-	-	-	
CDM 5-13	32x32	2.2	3	97	92	91	87	80	71	60	47	40	-	-	-	
CDM 5-14	32x32	2.2	3	104	100	98	93	87	77	65	51	43.5	-	-	-	
CDM 5-15	32x32	2.2	3	112	107	106	100	93	82	69	54	46.5	-	-	-	
CDM 5-16	32x32	2.2	3	119	114	112	107	99	88	74	58	50	-	-	-	
CDM 5-17	32x32	3	4	127	121	118.5	113	105	94	79	62	53	-	-	-	
CDM 5-18	32x32	3	4	134	128	126	120	111	99	84	66	56	-	-	-	
CDM 5-20	32x32	3	4	149	143	140	133	124	110	93	73	63	-	-	-	
CDM 5-21	32x32	3	4	157	150	147	140	130	116	98	77	66	-	-	-	
CDM 5-22	32x32	4	5.5	164	157	154	146	136	122	103	82	70	-	-	-	
CDM 5-23	32x32	4	5.5	172	165	161	153	142	128	108	86	74	-	-	-	
CDM 5-24	32x32	4	5.5	179	172	168	160	149	133	113	90	77	-	-	-	
CDM 5-25	32x32	4	5.5	187	179	175	167	155	139	117	93	80	-	-	-	
CDM 5-27	32x32	4	5.5	202	193	189	180	168	150	127	101	86	-	-	-	
CDM 5-28	32x32	4	5.5	210	201	197	187	174	156	132	105	90	-	-	-	
CDM 5-29	32x32	5.5	7.5	217	208	204	194	180	163	139	111	95	-	-	-	
CDM 5-30	32x32	5.5	7.5	225	216	212	201	186	169	144	115	98	-	-	-	
CDM 5-33	32x32	5.5	7.5	249	238	234	222	206	187	160	127	109	-	-	-	
CDM 10-1	40x40	0.75	1	11	-	-	-	10.2	10	9.5	9	9	8	7	4.5	
CDM 10-2	40x40	0.75	1	22.2	-	-	-	21	20.5	20	19	18	16.5	13.5	9.5	
CDM 10-3	40x40	1.1	1.5	33.3	-	-	-	31.5	31	30	28.5	28	25.5	22	16.5	
CDM 10-4	40x40	1.5	2	44.5	-	-	-	42	41	40	38	37	34	29	22	
CDM 10-5	40x40	2.2	3	56	-	-	-	52.5	51	50	48	47	43	37	28	
CDM 10-6	40x40	2.2	3	67	-	-	-	63	62	60	58	57	52	44	34	
CDM 10-7	40x40	3	4	78.5	-	-	-	74	73	71	69	67	62	52	40	
CDM 10-8	40x40	3	4	90	-	-	-	85	84	82	79	77	71	60	46	
CDM 10-9	40x40	4	5.5	101.5	-	-	-	96	94	92	89	87	80	67	52	
CDM 10-10	40x40	4	5.5	113	-	-	-	107	105	102	98	96	89	76	58	
CDM 10-11	40x40	4	5.5	124	-	-	-	118	115	112	108	106	98	84	64	
CDM 10-12	40x40	4.5	6	137	-	-	-	129	127	123	119	116	107	91	70	
CDM 10-13	40x40	5.5	7.5	147	-	-	-	140	138	134	130	127	116	99	76	
CDM 10-14	40x40	5.5	7.5	160	-	-	-	151	148	144	139	136	125	106	82	
CDM 10-15	40x40	5.5	7.5	171	-	-	-	162	159	154	149	145	134	114	88	
CDM 10-16	40x40	7.5	10	183	-	-	-	173	170	165	159	155	144	123	94	
CDM 10-17	40x40	7.5	10	194	-	-	-	184	180	175	169	165	153	130	100	
CDM 10-18	40x40	7.5	10	205	-	-	-	195	191	186	180	176	163	141	108	
CDM 10-19	40x40	7.5	10	217	-	-	-	206	201	196	190	186	172	147	113	
CDM 10-20	40x40	7.5	10	228	-	-	-	217	213	207	200	195	181	155	120	
CDM 10-21	40x40	7.5	10	240	-	-	-	228	223	217	210	205	191	162	126	
CDM 10-22	40x40	11	15	250	-	-	-	240	235	228	221	216	201	171	132	

ТЕХНИЧЕСКИЕ ДАННЫЕ

50Hz n=2900 об/мин

МОДЕЛЬ	DN	Мощность		Q=Подача																
				GPM 0	35	44	53	66	70	79	88	106	115	128	141	159	176			
		l/min 0	133	167	200	250	267	300	333	400	433	483	533	600	667					
		m³/h 0	8	10	12	15	16	18	20	24	26	29	32	36	40					
mm		kw	hp	H=Общий напор в метрах водяного столба (м)																
CDM 15-1	50x50	1.1	1.5	12.6	12.2	12	11.8	11	10.5	10	9	6.5	-	-	-	-	-			
CDM 15-2	50x50	2.2	3	26	24.5	24	23.5	22.5	21.5	20	18	13.5	-	-	-	-	-			
CDM 15-3	50x50	3	4	40	37.5	37	36.5	34.5	34	32	29	21	-	-	-	-	-			
CDM 15-4	50x50	4	5.5	54	50.5	50	49	47	46	43	39	28.5	-	-	-	-	-			
CDM 15-5	50x50	4	5.5	68	63	62	61	58	57	53	48	36	-	-	-	-	-			
CDM 15-6	50x50	5.5	7.5	82	76	75	73	69	67	63	58	43	-	-	-	-	-			
CDM 15-7	50x50	5.5	7.5	96	89	88	86	81	79	74	68	51	-	-	-	-	-			
CDM 15-8	50x50	7.5	10	110	102	100	98	93	91	85	78	59	-	-	-	-	-			
CDM 15-9	50x50	7.5	10	124	115	113	111	106	103	96	88	67	-	-	-	-	-			
CDM 15-10	50x50	11	15	138	128	126	124	118	115	107	98	75	-	-	-	-	-			
CDM 15-11	50x50	11	15	151	142	140	137	130	126	117	107	83	-	-	-	-	-			
CDM 15-12	50x50	11	15	166	154	152	149	142	138	129	117	90	-	-	-	-	-			
CDM 15-13	50x50	11	15	180	167	164	160	152	148	138	126	99	-	-	-	-	-			
CDM 15-14	50x50	11	15	194	180	177	173	165	160	149	136	106	-	-	-	-	-			
CDM 15-15	50x50	15	20	208	196	192	188	178	173	161	147	116	-	-	-	-	-			
CDM 15-16	50x50	15	20	222	209	205	200	189	184	172	157	125	-	-	-	-	-			
CDM 15-17	50x50	15	20	236	222	218	213	201	196	183	167	132	-	-	-	-	-			
CDM 15-18	50x50	15	20	250	235	231	225	213	207	194	177	141	-	-	-	-	-			
CDM 20-1	50x50	1.1	1.5	13.3	-	12.5	12.3	12	11.5	11	10.5	9.5	9	7	-	-	-			
CDM 20-2	50x50	2.2	3	27.2	-	25.5	25	24.5	24	23	22	20	18	14.5	-	-	-			
CDM 20-3	50x50	4	5.5	41.5	-	39.5	39	38	37	36	34.5	31	28	23.5	-	-	-			
CDM 20-4	50x50	5.5	7.5	55.5	-	52.5	51	50	49	48	46	41	37	31.5	-	-	-			
CDM 20-5	50x50	5.5	7.5	69.5	-	66	65	63	62	60	58	51	47	40	-	-	-			
CDM 20-6	50x50	7.5	10	83.8	-	79	78	76	75	73	70	62	58	48	-	-	-			
CDM 20-7	50x50	7.5	10	98	-	92.5	91	89	88	85	82	73	68	57.5	-	-	-			
CDM 20-8	50x50	11	15	113	-	106	105	102	101	98	95	84	77	66	-	-	-			
CDM 20-10	50x50	11	15	141	-	133	132	129	127	123	119	106	97	83	-	-	-			
CDM 20-12	50x50	15	20	171	-	160	158	155	153	149	143	127	117	100	-	-	-			
CDM 20-14	50x50	15	20	201	-	187	185	181	179	174	168	149	137	117	-	-	-			
CDM 20-17	50x50	18.5	25	244	-	228	225	220	218	212	205	182	168	147	-	-	-			
CDM32-1-1	65x65	1.5	2	15	-	-	-	-	14	14	13	12	12	11	9	7	4			
CDM32-1	65x65	2.2	3	20	-	-	-	-	18	18	17	15	15	14	13	11	8			
CDM32-2-2	65x65	3	4	33	-	-	-	-	29	29	28	26	25	22	20	16	11			
CDM32-2	65x65	4	5.5	40	-	-	-	-	36	35	34	32	31	29	27	23	18			
CDM32-3-2	65x65	5.5	7.5	50	-	-	-	-	47	46	44	41	40	37	33	28	21			
CDM32-3	65x65	5.5	7.5	57	-	-	-	-	54	53	51	48	46	43	40	35				

ТЕХНИЧЕСКИЕ ДАННЫЕ

50Hz n=2900 l/min

МОДЕЛЬ	DN	Мощность		Q=Подача																
				GPM	110	132	154	176	185	198	220	242	264	286	308	352	374	396	441	485
				l/min	417	500	583	667	700	750	833	917	1000	1083	1167	1333	1417	1500	1667	1833
				m ³ /h																
				25	30	35	40	42	45	50	55	60	65	70	80	85	90	100	110	
				H=Общий напор в метрах водяного столба (м)																
CDM42-1-1	80x80	3	4	20	19	18	17	16	15	13	11	-	-	-	-	-	-	-		
CDM42-1	80x80	4	5.5	24	23	22	21	20	19	18	16	-	-	-	-	-	-	-		
CDM42-2-2	80x80	5.5	7.5	40	38	36	33	32	30	27	23	-	-	-	-	-	-	-		
CDM42-2	80x80	7.5	10	48	46	44	42	41	39	35	31	-	-	-	-	-	-	-		
CDM42-3-2	80x80	11	15	63	61	58	54	52	50	44	38	-	-	-	-	-	-	-		
CDM42-3	80x80	11	15	71	69	66	63	61	58	53	47	-	-	-	-	-	-	-		
CDM42-4-2	80x80	15	20	87	84	80	75	73	69	62	54	-	-	-	-	-	-	-		
CDM42-4	80x80	15	20	95	92	88	84	81	78	71	62	-	-	-	-	-	-	-		
CDM42-5-2	80x80	18.5	25	111	107	102	96	93	88	80	69	-	-	-	-	-	-	-		
CDM42-5	80x80	18.5	25	119	115	110	105	101	97	88	78	-	-	-	-	-	-	-		
CDM42-6-2	80x80	22	30	135	130	124	117	113	108	97	85	-	-	-	-	-	-	-		
CDM42-6	80x80	22	30	143	138	132	125	122	116	106	93	-	-	-	-	-	-	-		
CDM42-7-2	80x80	30	40	158	152	146	138	134	127	115	100	-	-	-	-	-	-	-		
CDM42-7	80x80	30	40	166	161	154	146	142	135	124	109	-	-	-	-	-	-	-		
CDM42-8-2	80x80	30	40	182	175	168	159	154	146	133	116	-	-	-	-	-	-	-		
CDM42-8	80x80	30	40	190	184	176	167	162	154	141	124	-	-	-	-	-	-	-		
CDM42-9-2	80x80	30	40	205	198	190	180	174	166	150	132	-	-	-	-	-	-	-		
CDM42-9	80x80	37	50	214	207	198	188	183	174	159	140	-	-	-	-	-	-	-		
CDM42-10-2	80x80	37	50	230	221	212	200	194	185	168	147	-	-	-	-	-	-	-		
CDM42-10	80x80	37	50	238	230	220	209	203	193	177	155	-	-	-	-	-	-	-		
CDM42-11-2	80x80	45	60	255	246	236	223	217	206	188	165	-	-	-	-	-	-	-		
CDM42-11	80x80	45	60	263	255	244	232	225	214	196	173	-	-	-	-	-	-	-		
CDM42-12-2	80x80	45	60	280	270	259	245	238	226	206	181	-	-	-	-	-	-	-		
CDM42-12	80x80	45	60	289	280	268	255	247	236	216	190	-	-	-	-	-	-	-		
CDM42-13-2	80x80	45	60	305	294	282	267	259	247	225	198	-	-	-	-	-	-	-		
CDM65-1-1	100x100	4	5.5	-	19	19	18	18	17	16	15	14	13	11	8	-	-	-		
CDM65-1	100x100	5.5	7.5	-	27	26	25	25	24	23	22	21	20	18	15	-	-	-		
CDM65-2-2	100x100	7.5	10	-	39	38	36	36	35	33	31	29	26	23	17	-	-	-		
CDM65-2-1	100x100	11	15	-	46	45	44	43	42	40	38	36	33	30	24	-	-	-		
CDM65-2	100x100	11	15	-	53	52	51	50	49	47	45	43	40	37	30	-	-	-		
CDM65-3-2	100x100	15	20	-	66	64	62	61	59	56	53	50	46	41	32	-	-	-		
CDM65-3-1	100x100	15	20	-	73	71	69	68	66	63	60	57	53	48	39	-	-	-		
CDM65-3	100x100	18.5	25	-	80	78	76	75	73	70	67	64	60	55	46	-	-	-		
CDM65-4-2	100x100	18.5	25	-	92	90	87	86	84	80	76	71	66	60	47	-	-	-		
CDM65-4-1	100x100	22	30	-	100	97	94	93	91	87	83	78	73	67	54	-	-	-		
CDM65-4	100x100	22	30	-	107	104	101	100	98	94	90	85	80	74	61	-	-	-		
CDM65-5-2	100x100	30	40	-	121	118	114	112	110	105	100	95	88	80	64	-	-	-		
CDM65-5-1	100x100	30	40	-	128	125	121	119	117	112	107	102	95	87	71	-	-	-		
CDM65-5	100x100	30	40	-	136	133	129	127	124	119	114	109	102	94	78	-	-	-		
CDM65-6-2	100x100	30	40	-	150	146	142	140	137	131	125	118	110	101	81	-	-	-		
CDM65-6-1	100x100	37	50	-	157	153	149	147	144	138	132	125	117	108	88	-	-	-		
CDM65-6	100x100	37	50	-	164	160	156	154	151	145	139	132	124	115	95	-	-	-		
CDM65-7-2	100x100	37	50	-	179	174	169	167	163	156	149	141	132	121	99	-	-	-		
CDM65-7-1	100x100	37	50	-	186	181	176	174	170	163	156	148	139	128	106	-	-	-		
CDM65-7	100x100	45	60	-	193	188	183	181	177	170	163	155	146	135	112	-	-	-		
CDM65-8-2	100x100	45	60	-	207	202	196	193	189	182	173	164	154	142	116	-	-	-		
CDM65-8-1	100x100	45	60	-	215	209	203	200	196	189	180	171	161	149	123	-	-	-		
CDM85-1-1	100x100	5.5	7.5	-	-	-	-	-	-	22	21	19	18	17	16	14	13	10	6	
CDM85-1	100x100	7.5	10	-	-	-	-	-	-	25	25	24	23	22	21	20	19	16	12	
CDM85-2-2	100x100	11	15	-	-	-	-	-	-	41	40	39	38	36	32	30	28	22	15	
CDM85-2	100x100	15	20	-	-	-	-	-	-	53	52	50	49	47	44	41	40	36	30	
CDM85-3-2	100x100	18.5	25	-	-	-	-	-	-	68	67	65	63	60	55	52	49	41	32	
CDM85-3	100x100	22	30	-	-	-	-	-	-	81	79	77	75	72	67	64	62	55	48	
CDM85-4-2	100x100	30	40	-	-	-	-	-	-	98	96	93	90	87	80	75	72	62	50	
CDM85-4	100x100	30	40	-	-	-	-	-	-	110	108	105	103	100	92	86	84	76	66	
CDM85-5-2	100x100	37	50	-	-	-	-	-	-	126	123	120	117	113	104	98	93	81	68	
CDM85-5	100x100	37	50	-	-	-	-	-	-	139	135	131	128	124	115	110	106	94	83	
CDM85-6-2	100x100	45	60	-	-	-	-	-	-	155	152	148	144	139	129	122	117	102	86	
CDM85-6	100x100	45	60	-	-	-	-	-	-	168	164	160	155	150	141	134	130	117	103	

МАТЕРИАЛ

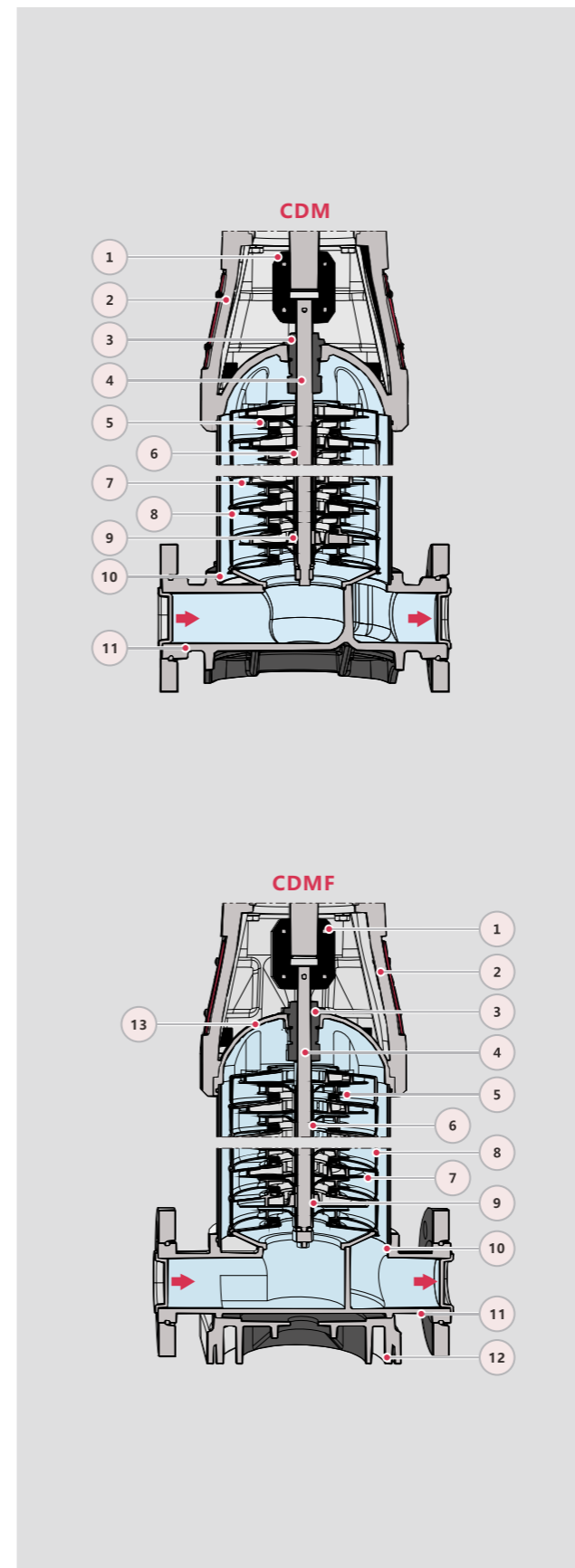

No.	Описание	Материал
1	Муфта	Углеродистая сталь
2	Корпус насоса	Чугун
3	Механическое уплотнение	TuC&Carbon
4	Вал	нержавеющая сталь 304
5	Рабочее колесо	нержавеющая сталь 304
6	Втулка крыльчатки	нержавеющая сталь 304
7	Диффузор	SUS304 Inox304 Inox304 CVC304
8	Поддержка диффузора	нержавеющая сталь 304
9	Подшипник	Tungsten Carbide Carburo Tungsteno Carbure tungstène Карбид вольфрама
10	Цилиндр	нержавеющая сталь 304
11	Вход и выход	CDM: Чугун CDMF: нержавеющая сталь 304
12	Опорная плита	Алюминий
13	Уплотнительная база	нержавеющая сталь 304

КРИВАЯ ПРОИЗВОДИТЕЛЬНОСТИ

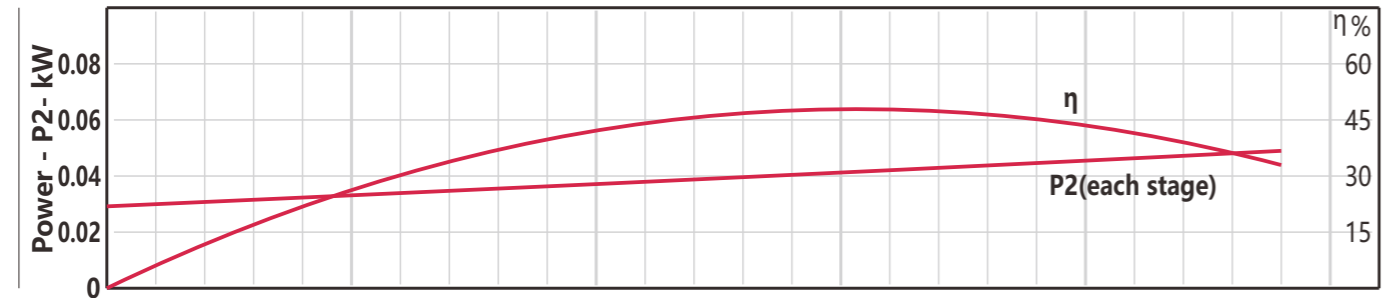
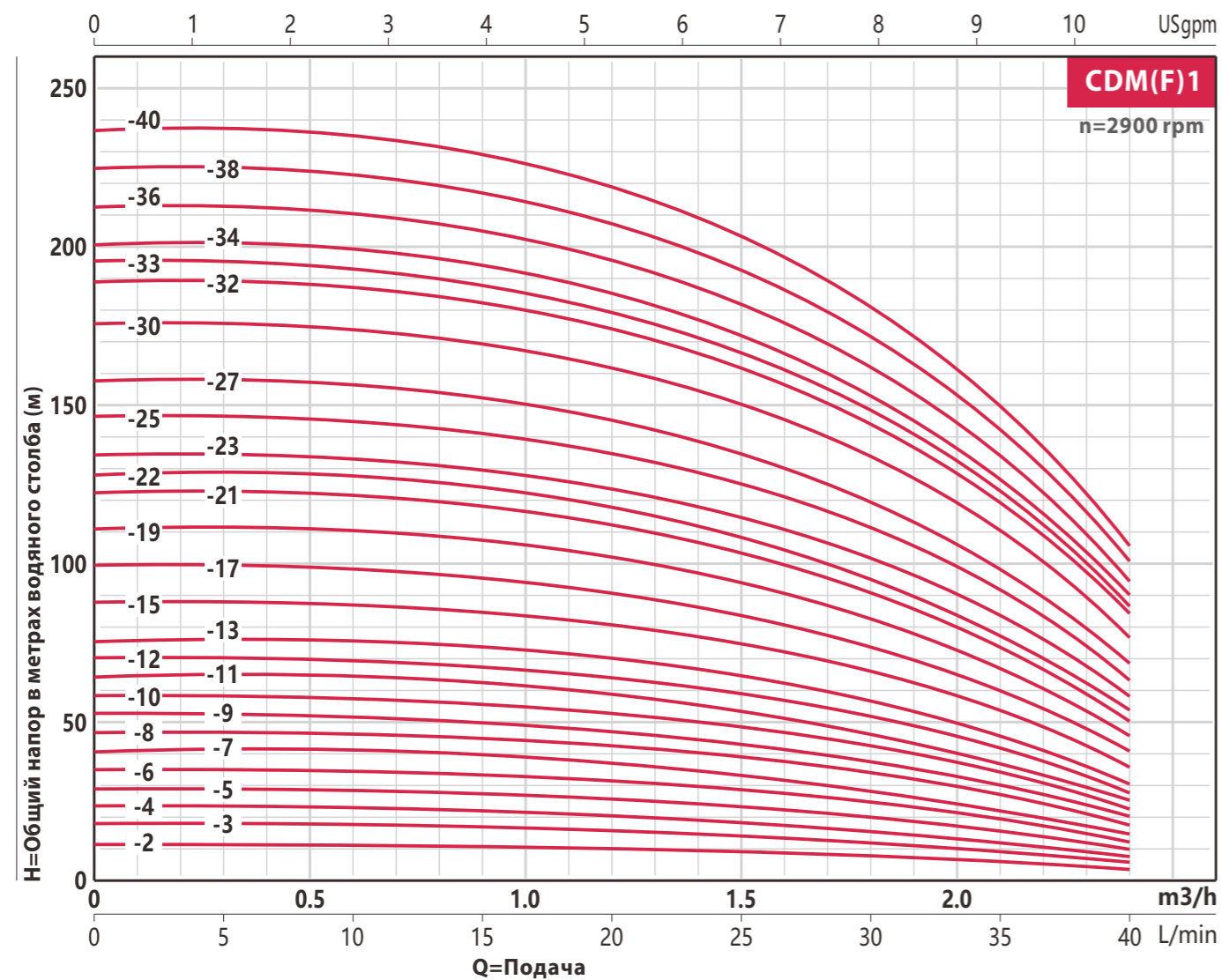

КРИВАЯ ПРОИЗВОДИТЕЛЬНОСТИ

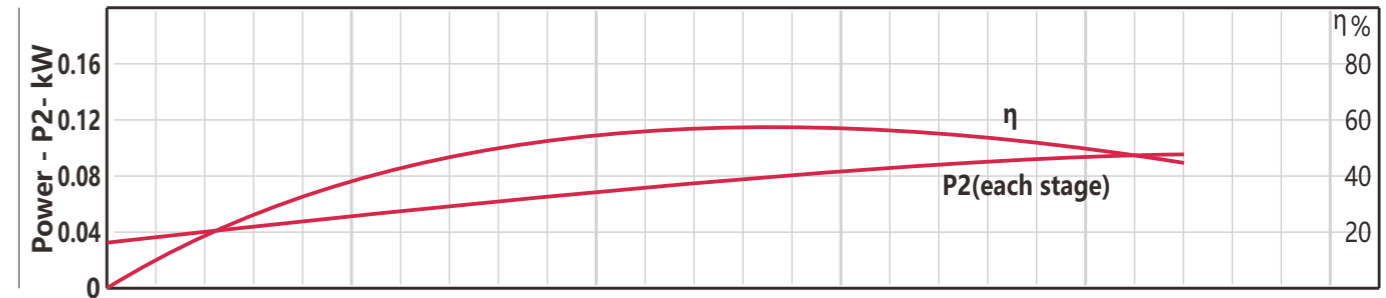
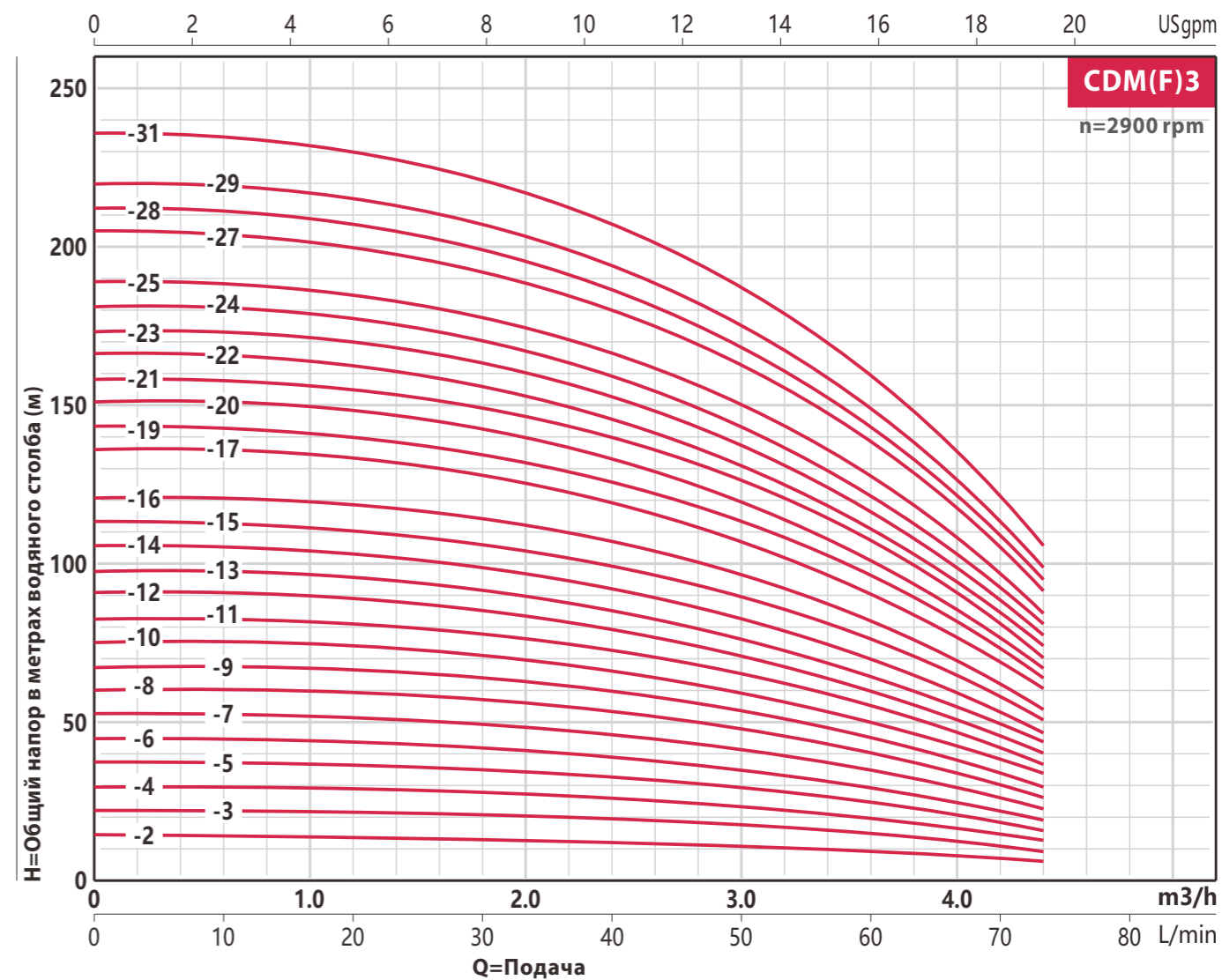

КРИВАЯ ПРОИЗВОДИТЕЛЬНОСТИ

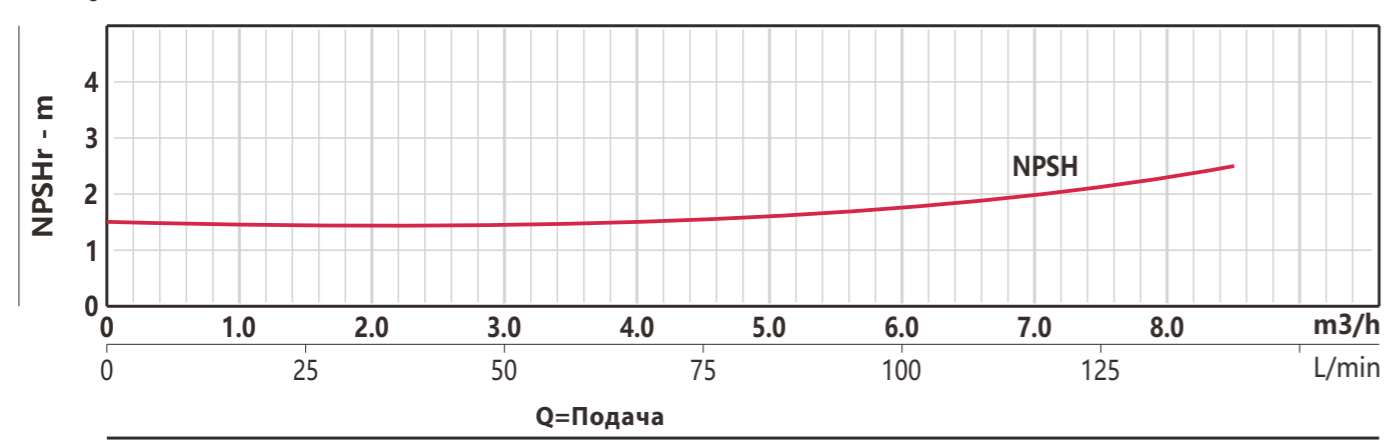
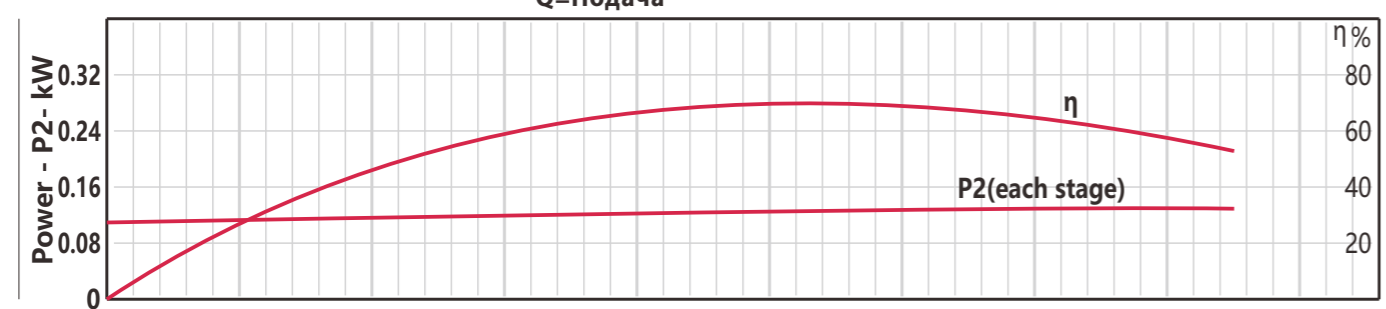
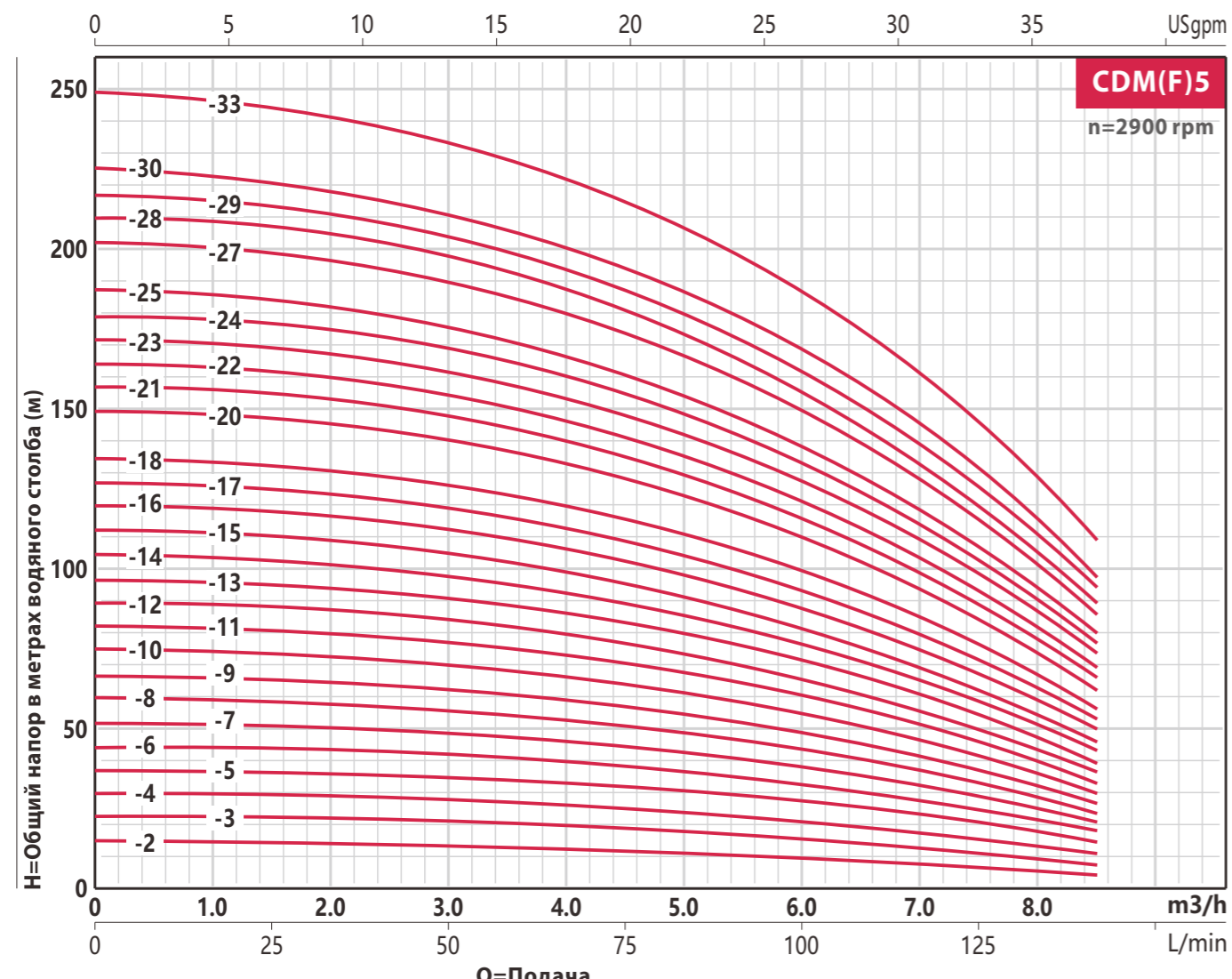

КРИВАЯ ПРОИЗВОДИТЕЛЬНОСТИ

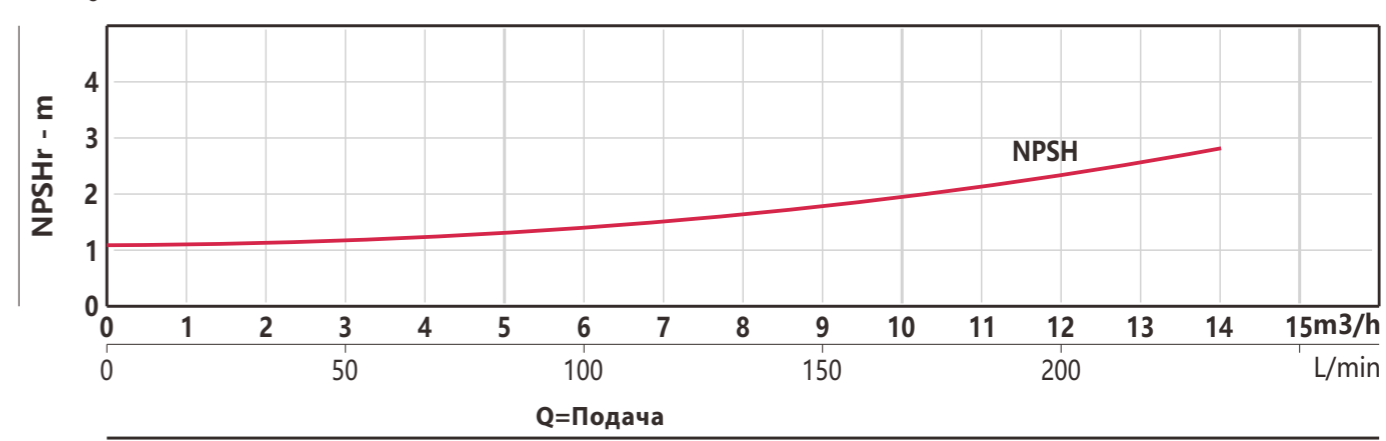
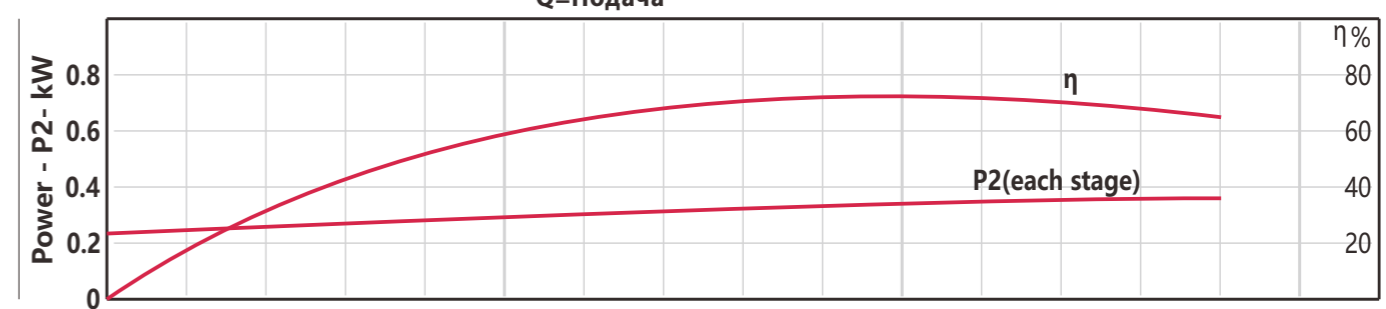
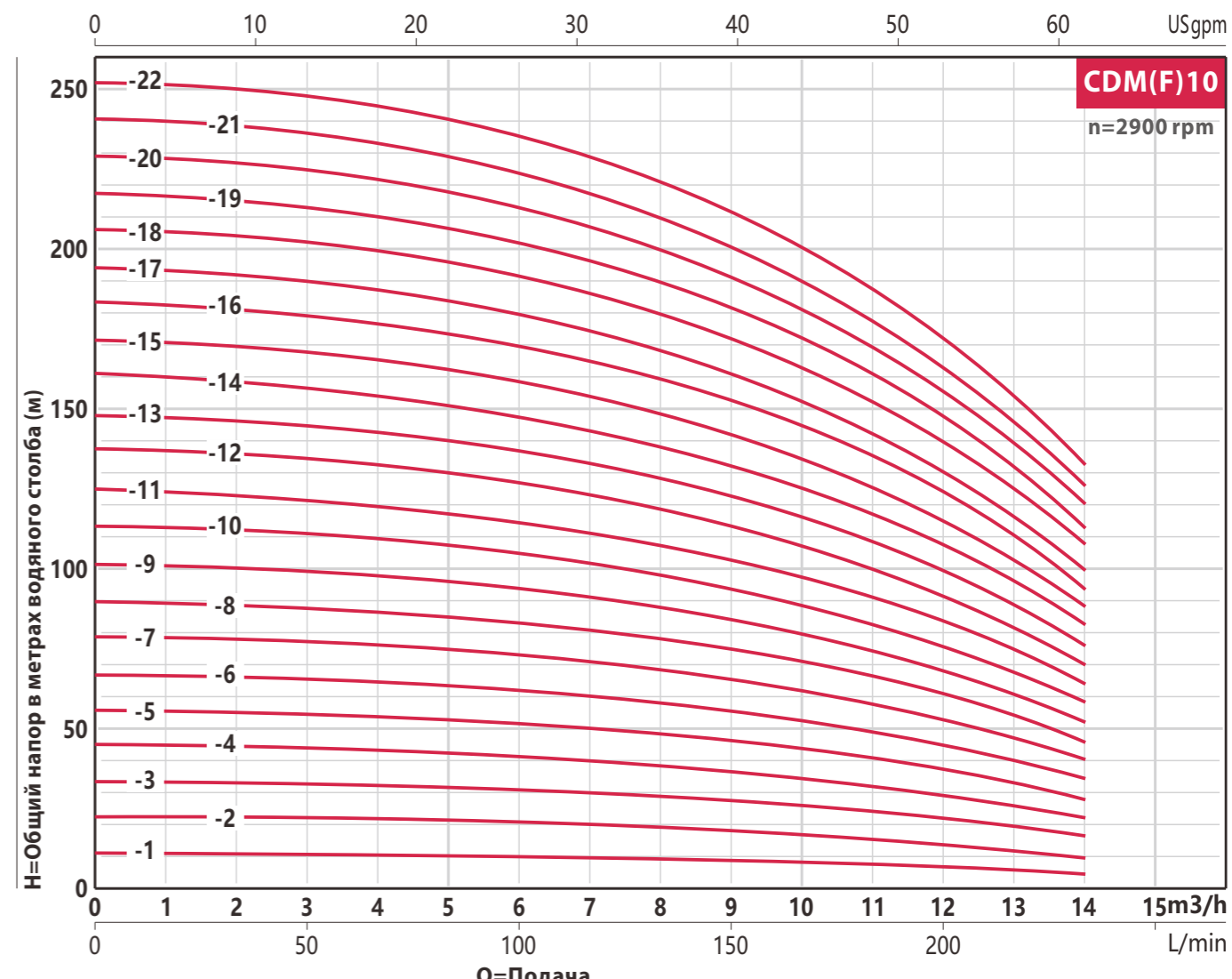

КРИВАЯ ПРОИЗВОДИТЕЛЬНОСТИ

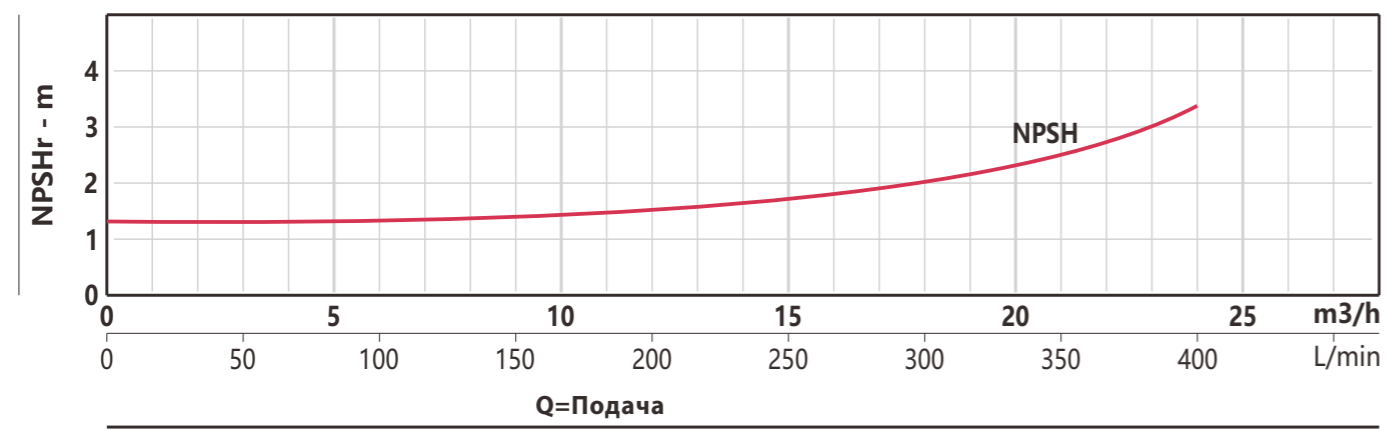
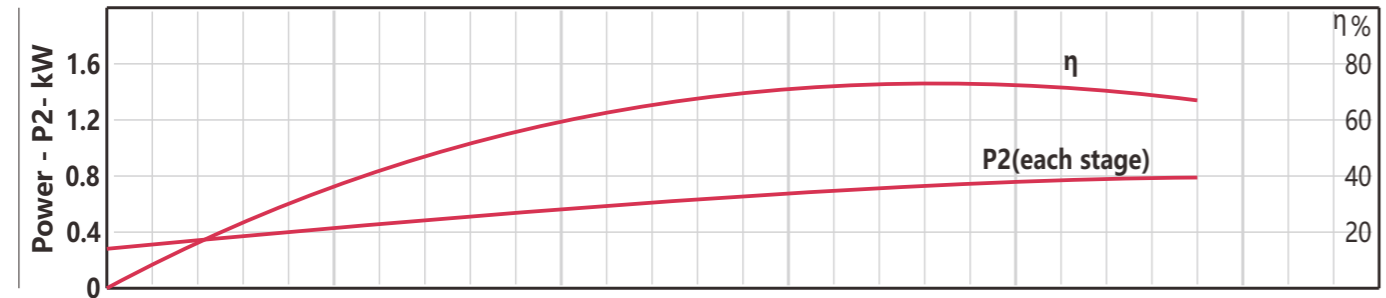
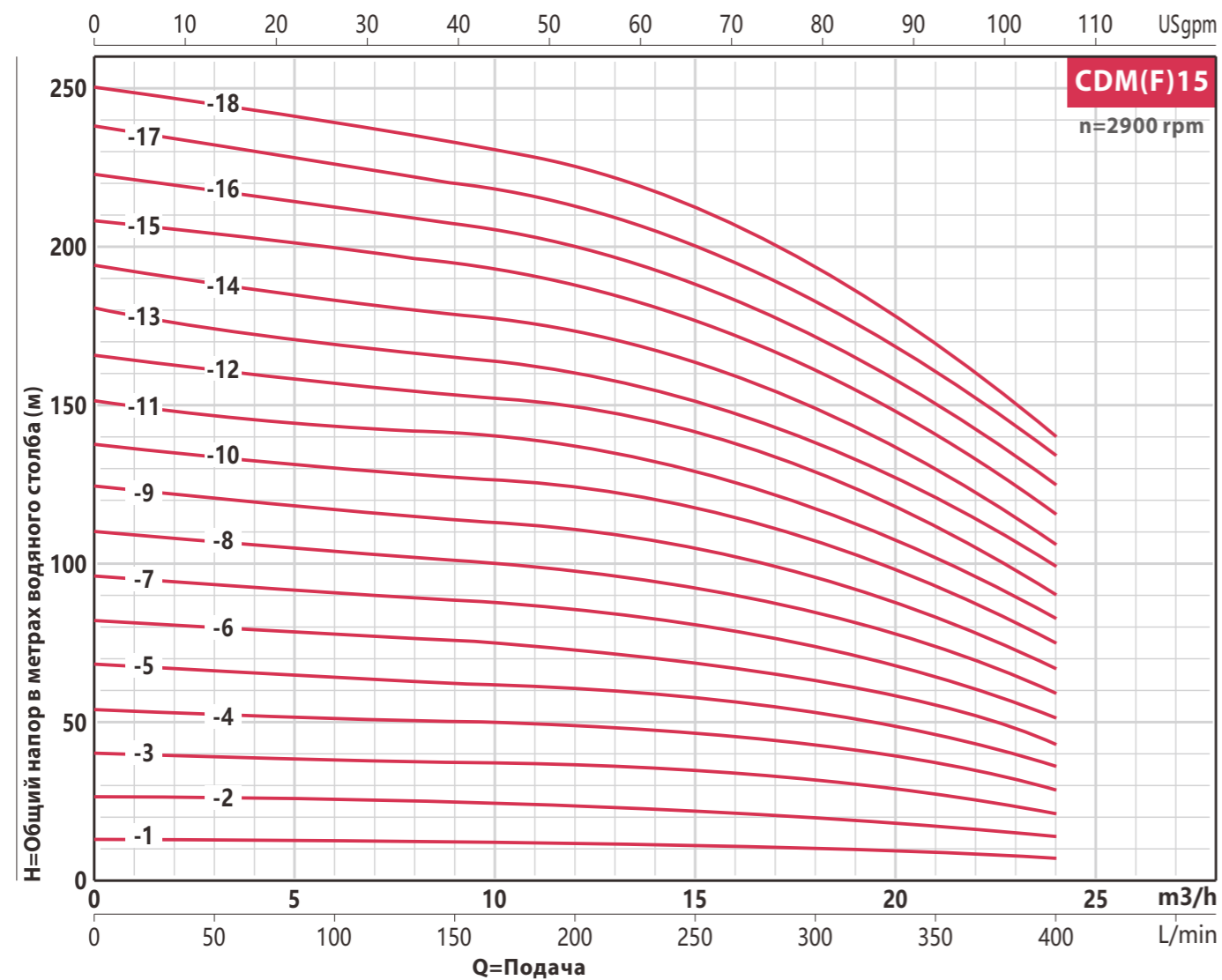

КРИВАЯ ПРОИЗВОДИТЕЛЬНОСТИ

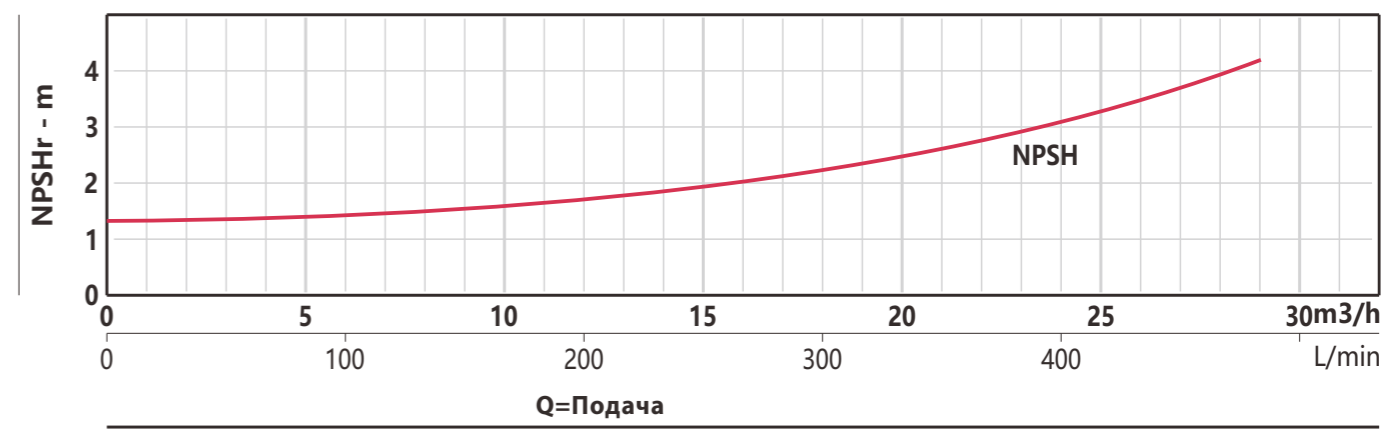
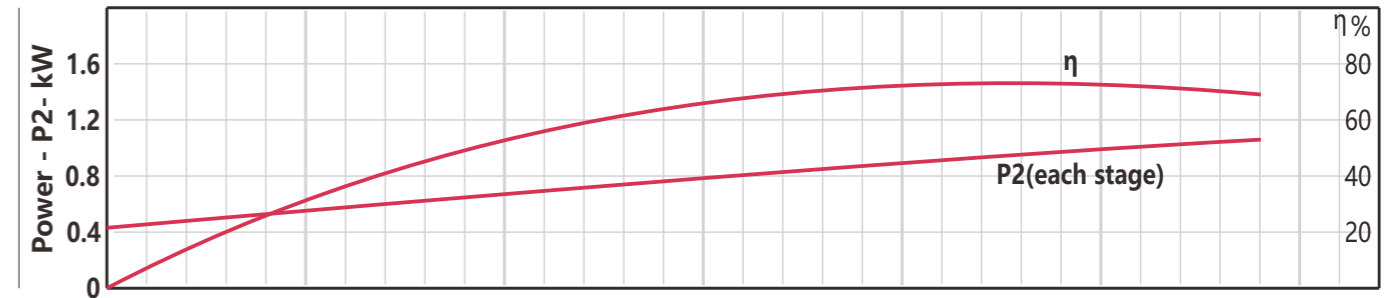
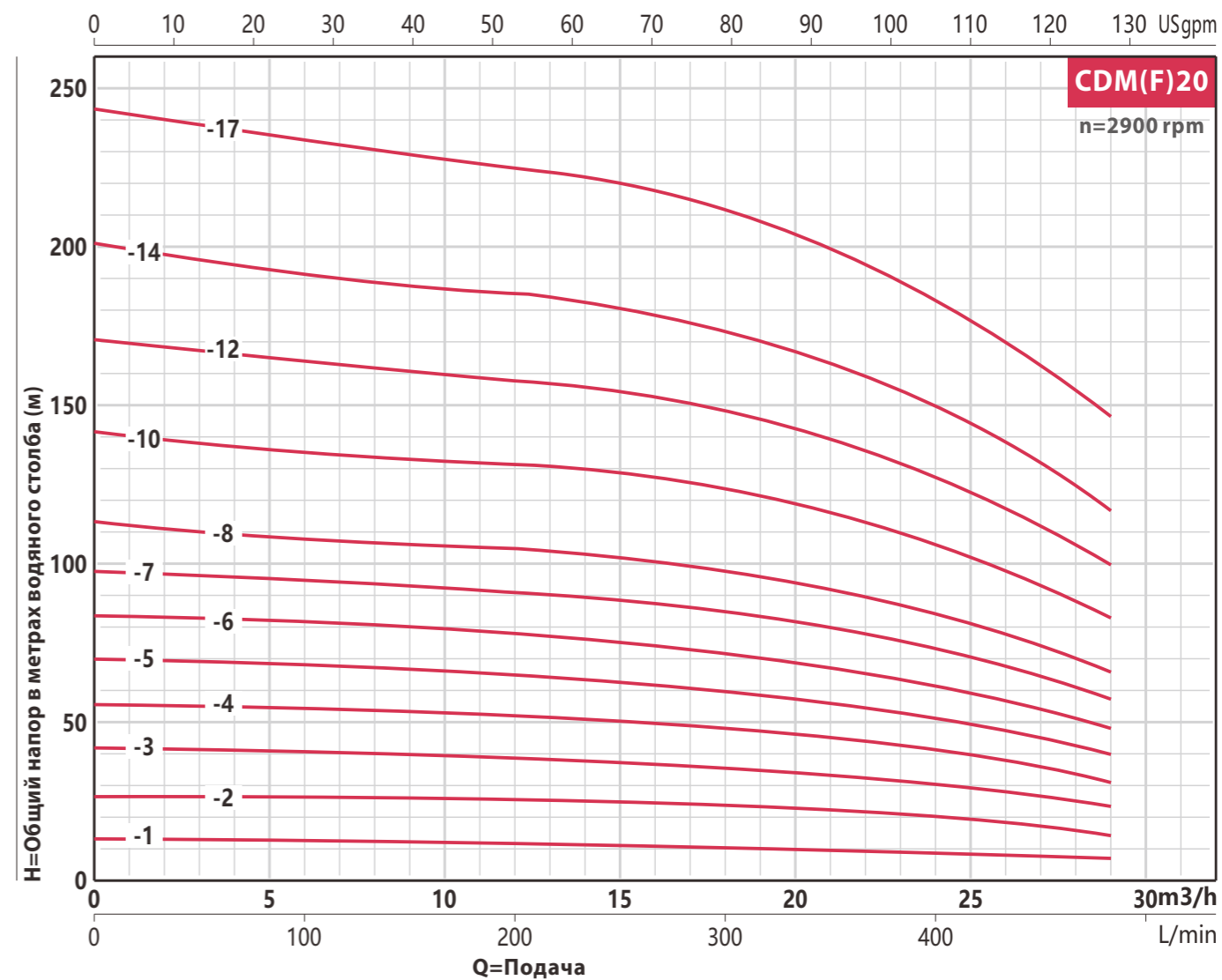

КРИВАЯ ПРОИЗВОДИТЕЛЬНОСТИ

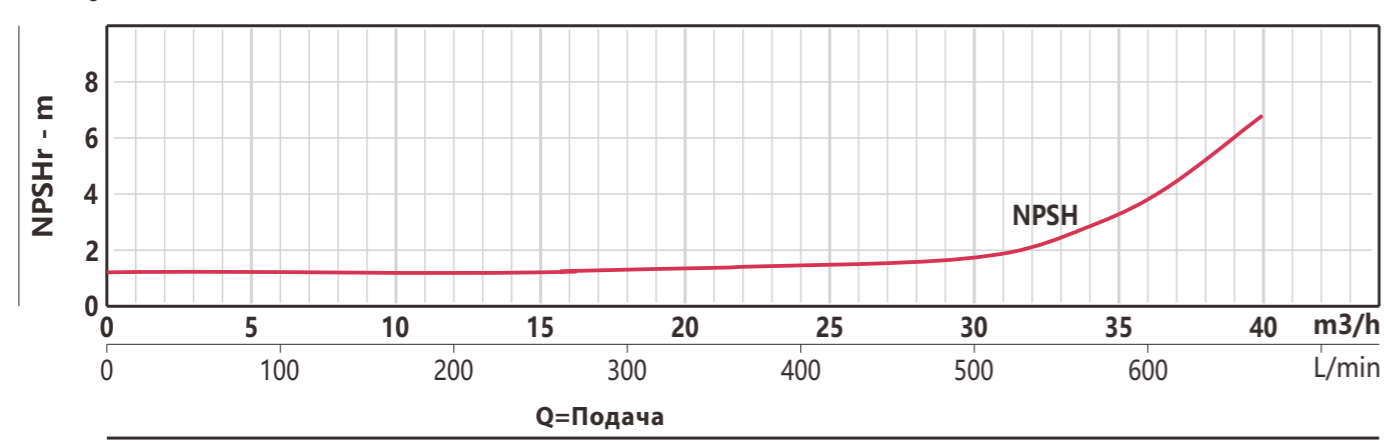
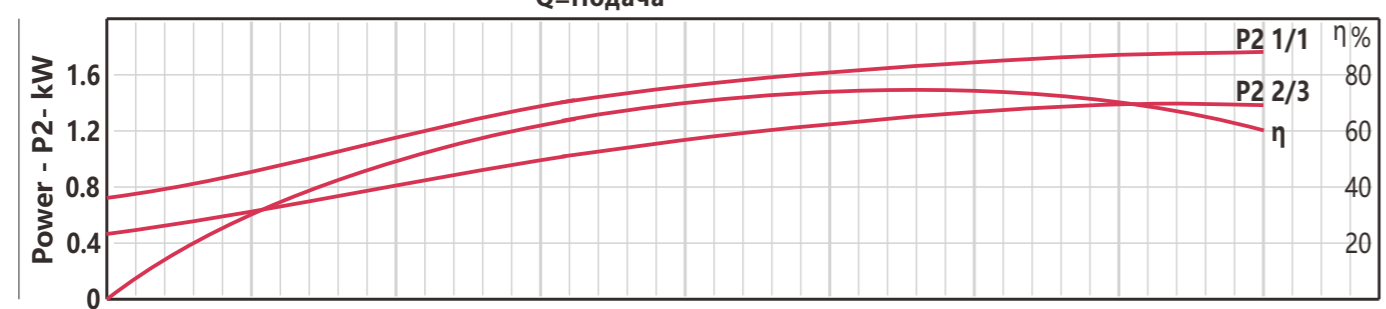
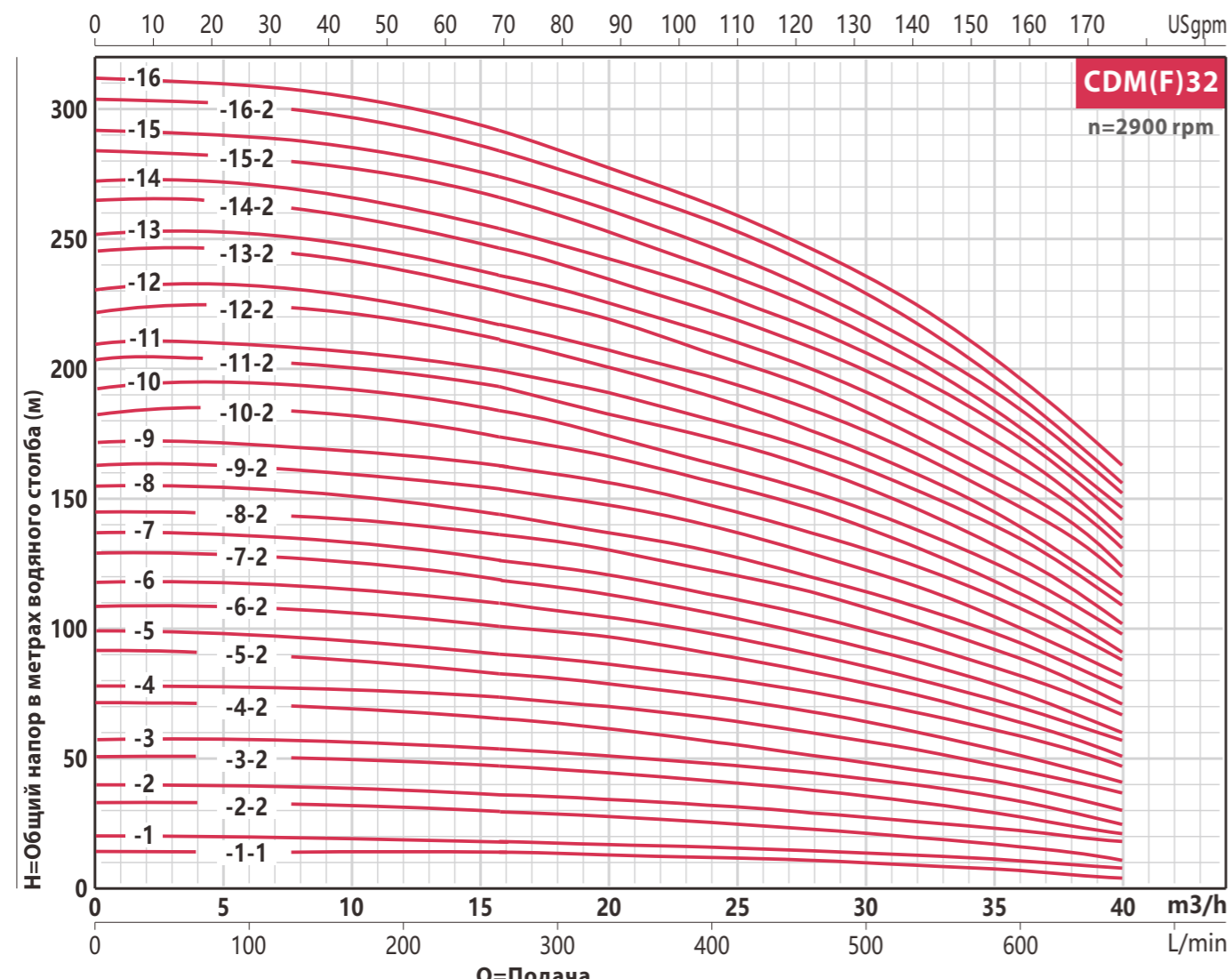

КРИВАЯ ПРОИЗВОДИТЕЛЬНОСТИ

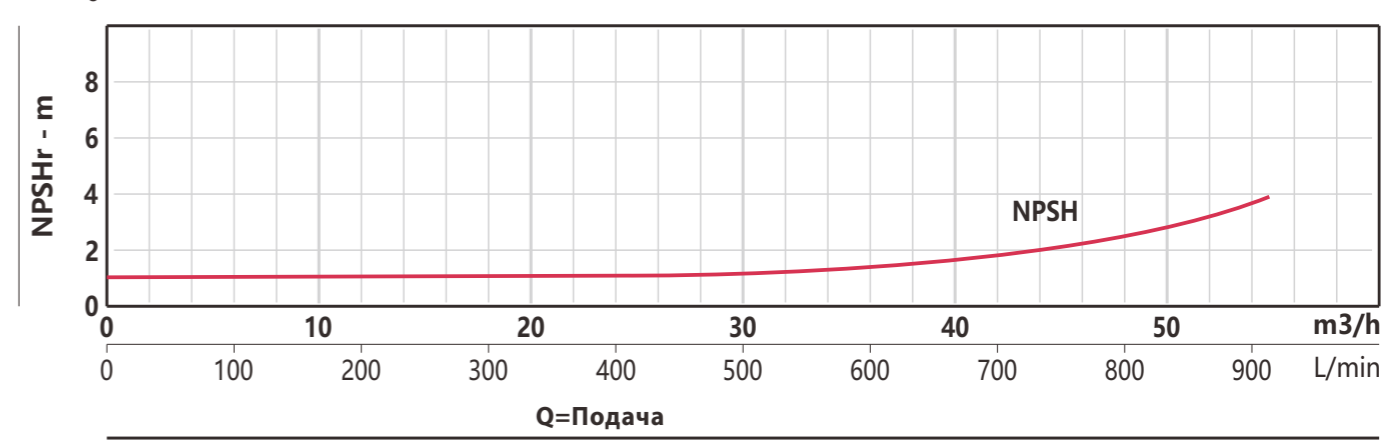
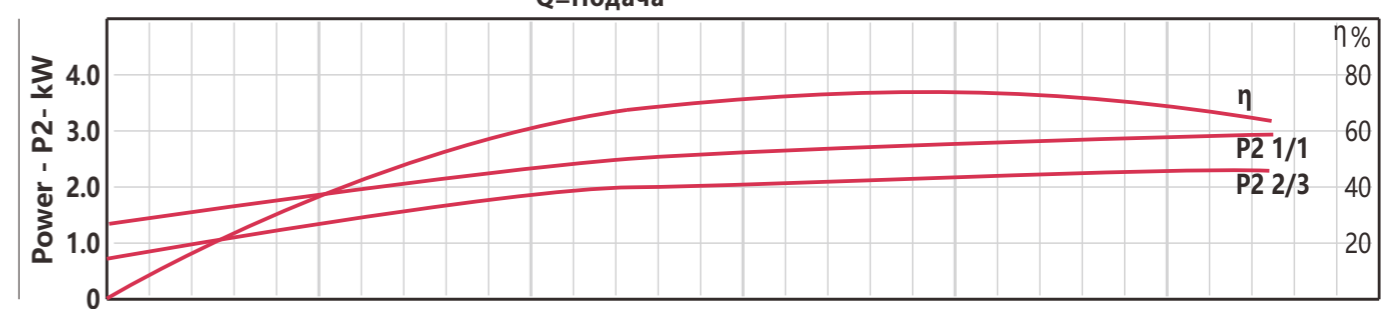
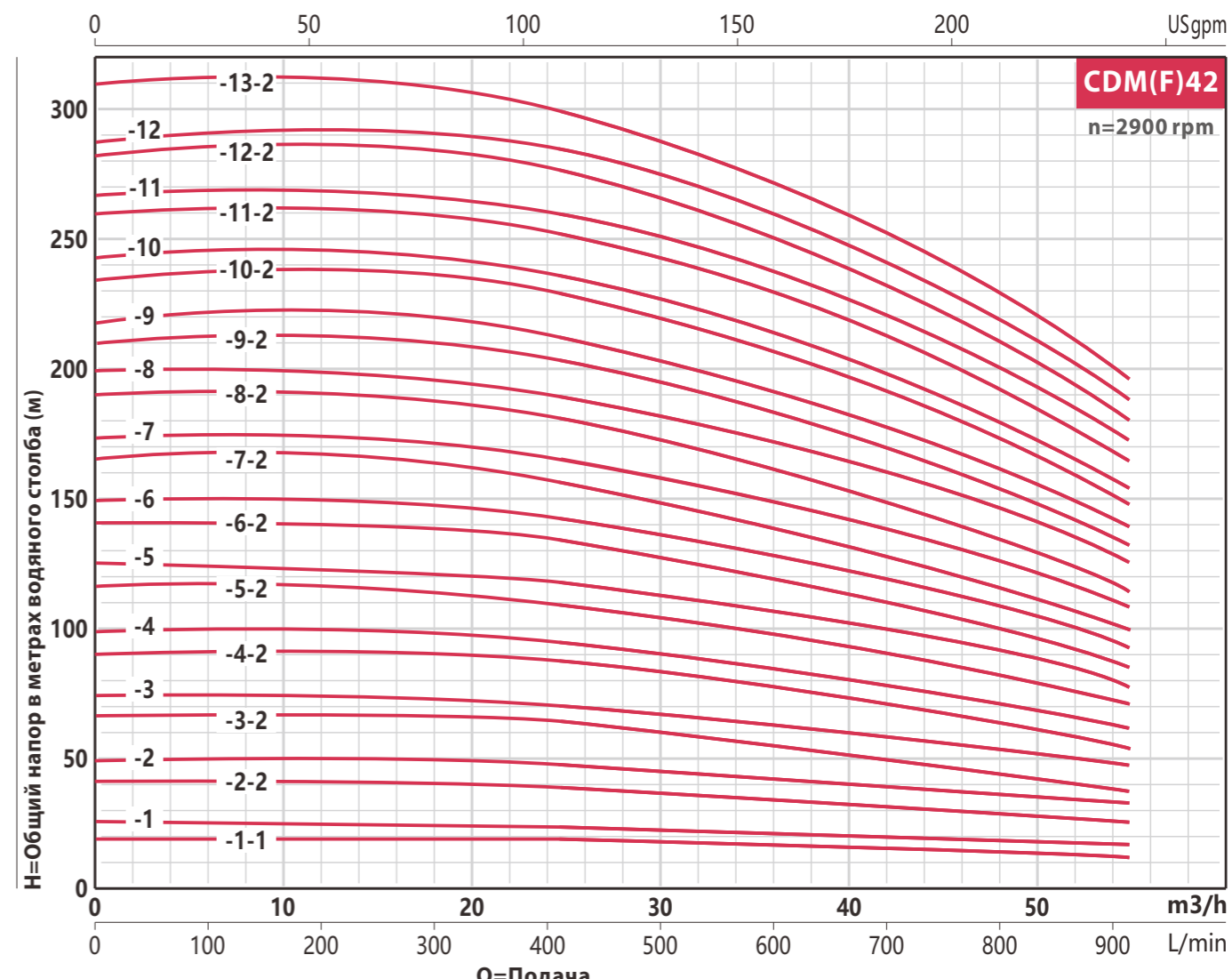

КРИВАЯ ПРОИЗВОДИТЕЛЬНОСТИ

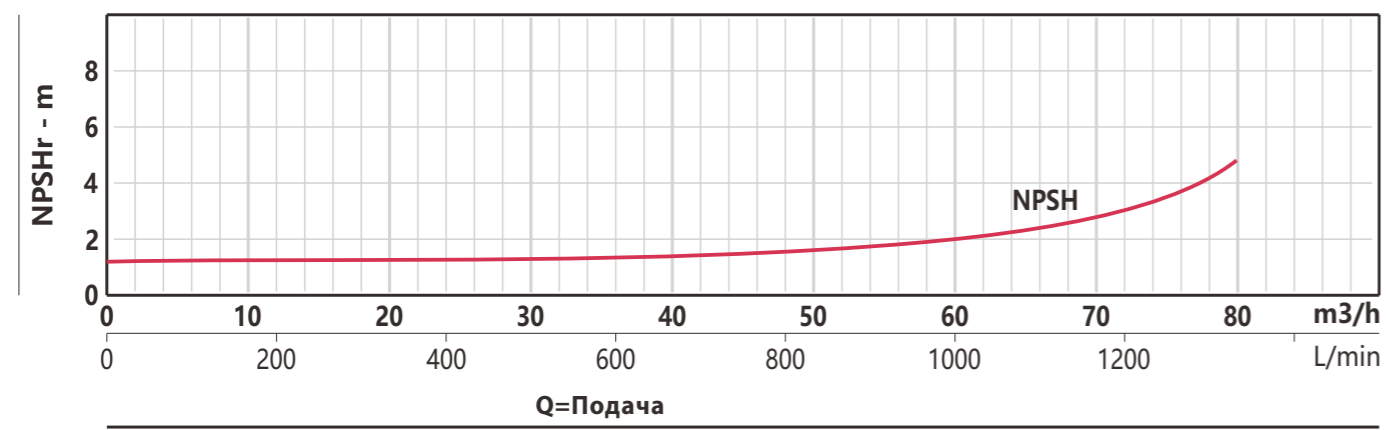
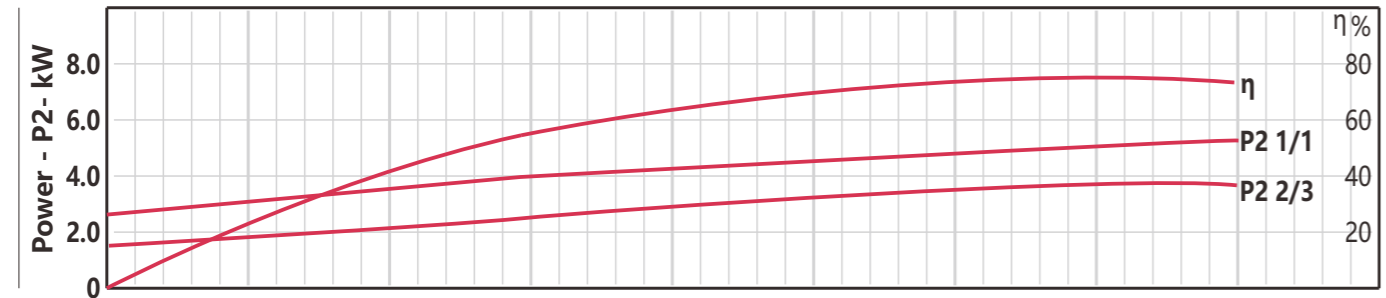
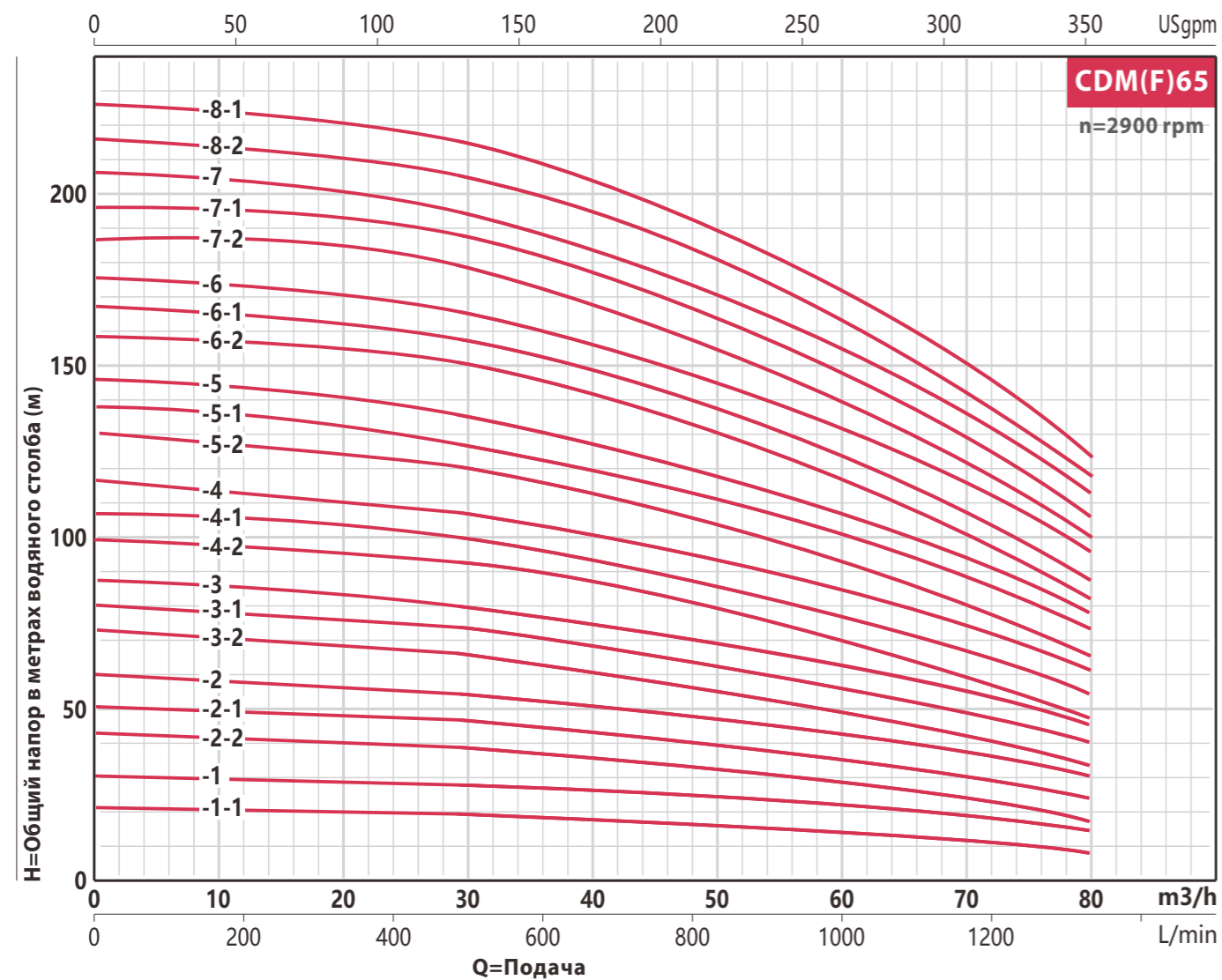

КРИВАЯ ПРОИЗВОДИТЕЛЬНОСТИ

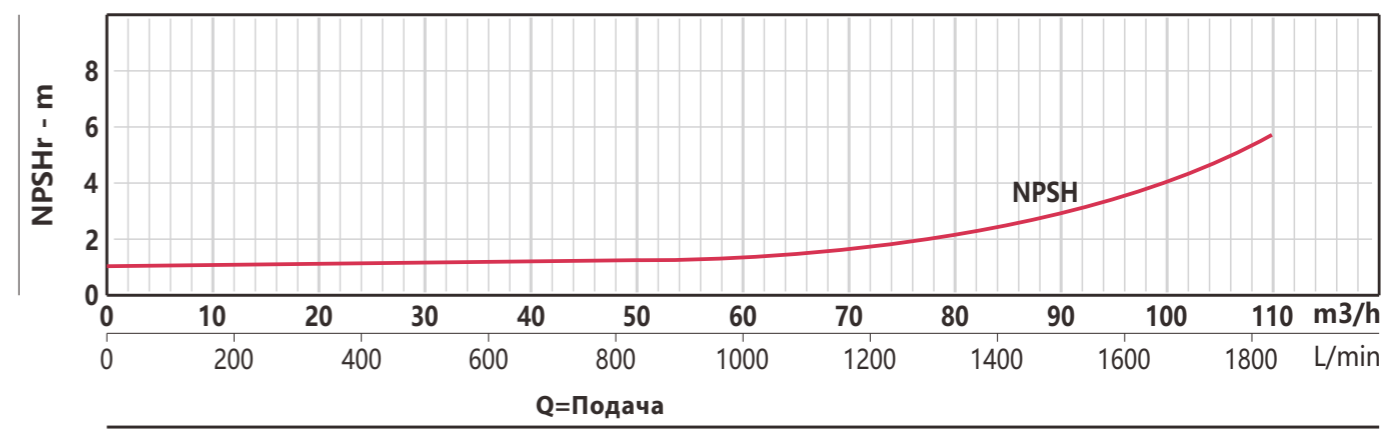
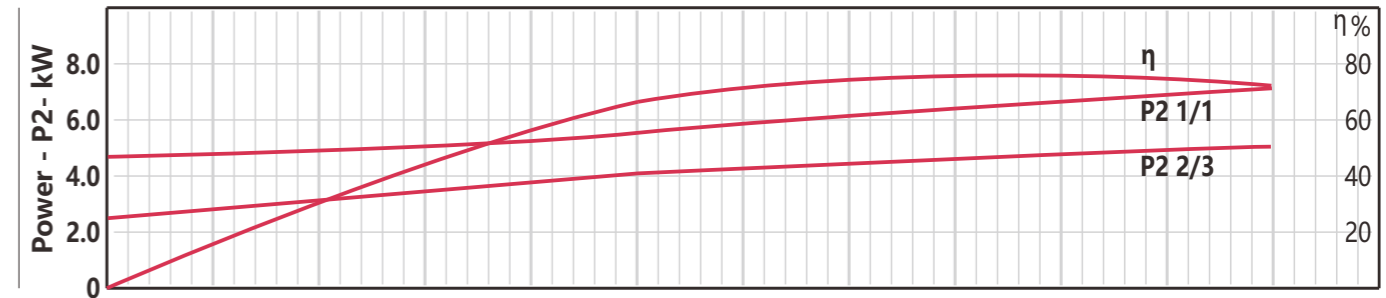
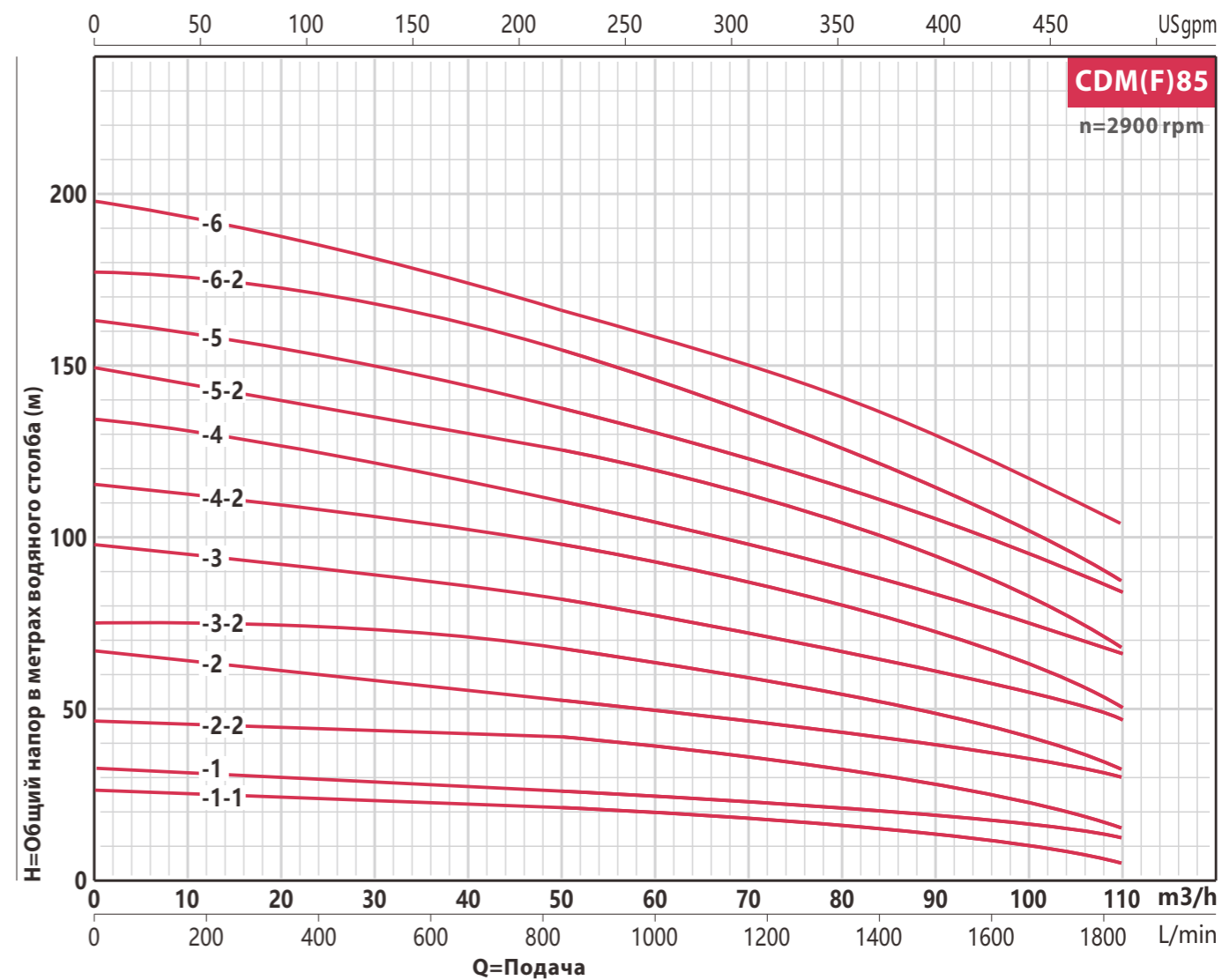

РАЗМЕРЫ И ВЕС

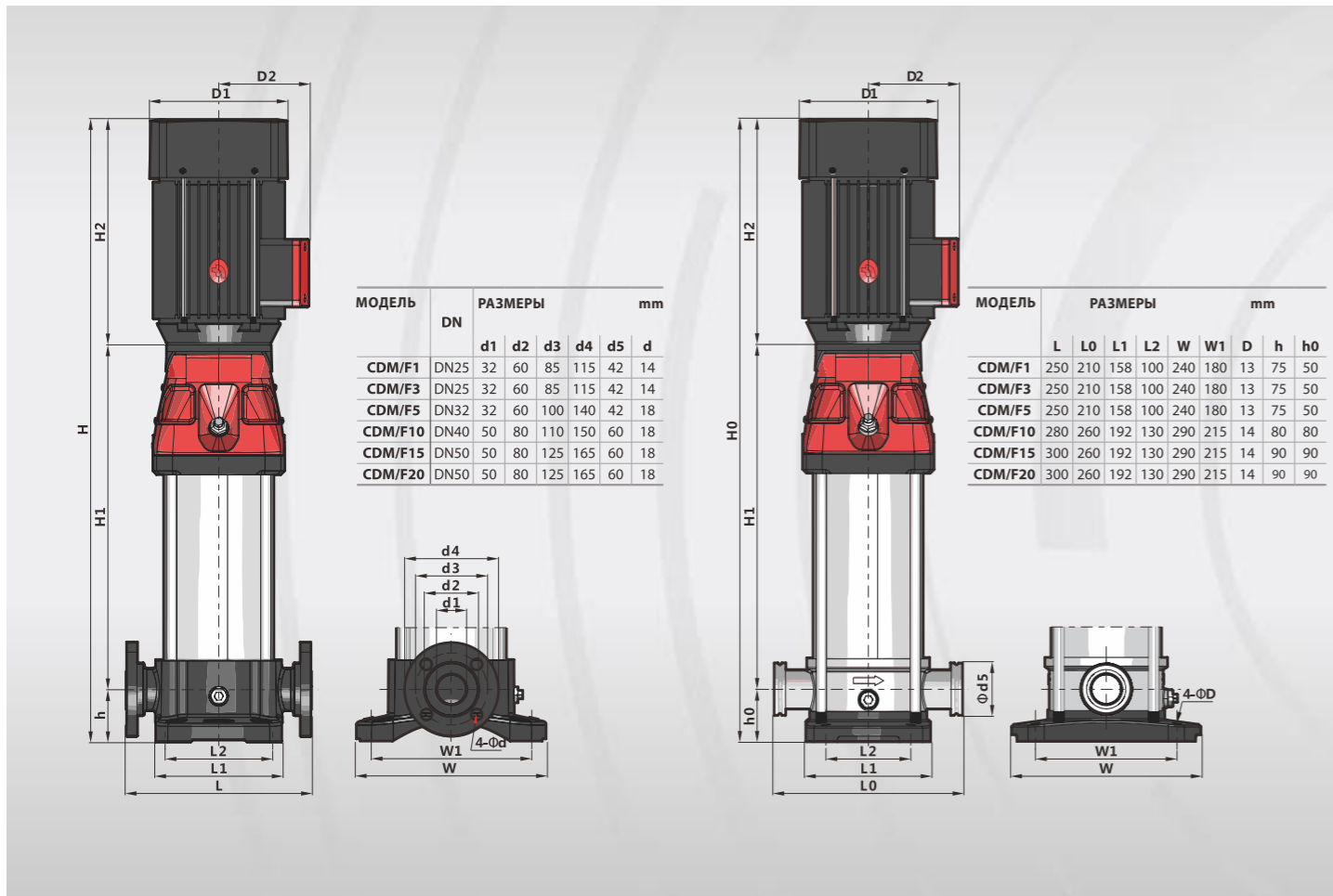

МОДЕЛЬ	РАЗМЕРЫ					N.W kg	
	H1	H2	H/H0	D1	D2	CDM	CDMF
1-2	187	215	477/452	148	117	23	19
1-3	207	215	497/472	148	117	23	19
1-4	227	215	517/492	148	117	24	20
1-5	247	215	537/512	148	117	24	20
1-6	267	215	557/532	148	117	25	21
1-7	287	215	577/552	148	117	25	21
1-8	307	215	597/572	148	117	27	23
1-9	327	215	617/592	148	117	27	23
1-10	347	215	637/612	148	117	28	24
1-11	367	215	657/632	148	117	28	24
1-12	397	245	717/692	170	142	31	27
1-13	417	245	737/712	170	142	31	27
1-15	457	245	777/752	170	142	32	28
1-17	497	245	817/792	170	142	35	31
1-19	537	245	857/832	170	142	36	32
1-21	577	245	897/872	170	142	36	32
1-22	597	245	917/892	170	142	37	33
1-23	617	290	937/912	190	155	43	39
1-25	667	290	1032/1007	190	155	44	40
1-27	707	290	1072/1047	190	155	45	41
1-30	767	290	1132/1107	190	155	46	42
1-32	807	290	1172/1147	190	155	49	45
1-33	827	290	1192/1167	190	155	49	45
1-34	847	290	1212/1187	190	155	50	46
1-36	887	290	1252/1227	190	155	51	47
1-38	927	290	1292/1267	190	155	51	47
1-40	967	290	1332/1307	190	155	52	48

МОДЕЛЬ	РАЗМЕРЫ					N.W kg	
	H1	H2	H/H0	D1	D2	CDM	CDMF
3-2	187	215	477/452	148	117	24	20
3-3	207	215	497/472	148	117	24	20
3-4	227	215	517/492	148	117	25	21
3-5	247	215	537/512	148	117	26	22
3-6	267	215	557/532	148	117	27	23
3-7	297	245	617/592	170	142	30	26
3-8	317	245	637/612	170	142	30	26
3-9	337	245	657/632	170	142	32	28
3-10	357	245	677/652	170	142	33	29
3-11	377	245	697/672	170	142	33	29
3-12	397	245	717/692	170	142	34	30
3-13	427	290	792/767	190	155	39	35
3-14	447	290	812/787	190	155	40	36
3-15	467	290	832/807	190	155	40	36
3-16	487	290	852/827	190	155	41	37
3-18	527	290	892/867	190	155	43	39
3-19	547	290	912/887	190	155	44	40
3-20	567	290	932/907	190	155	44	40
3-21	587	290	952/927	190	155	45	41
3-22	607	290	972/947	190	155	45	41
3-23	627	290	992/967	190	155	46	42
3-24	647	290	1012/987	190	155	46	42
3-25	677	345	1097/1072	197	165	57	53
3-27	717	345	1137/1112	197	165	58	54
3-28	737	345	1157/1132	197	165	58	54
3-29	757	345	1177/1152	197	165	58	54
3-31	797	345	1217/1192	197	165	59	55

РАЗМЕРЫ И ВЕС

МОДЕЛЬ	РАЗМЕРЫ					N.W kg	
	H1	H2	H/H0	D1	D2	CDM	CDMF
5-2	201	215	491/466	148	117	24	19
5-3	228	215	518/493	148	117	26	21
5-4	255	215	545/520	148	117	27	22
5-5	292	245	612/587	170	142	30	25
5-6	319	245	639/614	170	142	32	27
5-7	346	245	666/641	170	142	32	27
5-8	373	245	693/668	170	142	33	28
5-9	410	290	775/750	190	155	38	33
5-10	437	290	802/777	190	155	39	34
5-11	464	290	829/804	190	155	39	34
5-12	491	290	856/831	190	155	42	37
5-13	518	290	883/858	190	155	42	37
5-14	545	290	910/885	190	155	43	38
5-15	572	290	937/912	190	155	43	38
5-16	599	290	964/939	190	155	44	39
5-17	636	345	1056/1030	197	165	55	50
5-18	663	345	1083/1058	197	165	55	50
5-20	717	345	1137/1112	197	165	56	51
5-21	744	345	1164/1139	197	165	57	52
5-22	771	355	1201/1176	230	188	64	59
5-23	798	355	1228/1203	230	188	65	60
5-24	825	355	1255/1230	230	188	65	60
5-25	852	355	1282/1257	230	188	66	61
5-27	906	355	1336/1311	230	188	67	62
5-28	933	355	1363/1338	230	188	67	62
5-29	1035	390	1500/1475	260	208	87	82
5-30	1062	390	1527/1502	260	208	88	83
5-33	1143	390	1608/1583	260	208	89	84

МОДЕЛЬ	РАЗМЕРЫ					N.W kg	
	H1	H2	H/H0	D1	D2	CDM	CDMF
15-1	297	245	632	170	142	40	33
15-2	307	290	687	190	155	48	41
15-3	362	345	797	197	165	59	52
15-4	407	355	852	230	188	66	59
15-5	452	355	897	230	188	68	61
15-6	575	390	1055	260	208	90	83
15-7	620	390	1100	260	208	91	84
15-8	665	390	1145	260	208	98	91
15-9	710	390	1190	260	208	99	92
15-10	785	500	175	330	255	157	150
15-11	830	500	1420	330	255	159	152
15-12	875	500	1465	330	255	160	153
15-13	920	500	1510	330	255	162	155
15-14	965	500	1555	330	255	163	156
15-15	1010	500	1600	330	255	179	172
15-16	1055	500	1645	330	255	181	174
15-17	1100	500	1690	330	255	182	175
15-18	1145	500	1735	330	255	184	177

МОДЕЛЬ	РАЗМЕРЫ					N.W kg	
	H1	H2	H/H0	D1	D2	CDM	CDMF
10-1	267	245	592	170	142	31	29
10-2	267	245	592	170	142	32	30
10-3	297	245	622	170	142	35	33
10-4	337	290	707	190	155	41	39
10-5	367	290	737	190	155	45	43
10-6	397	290	767	190	155	46	44
10-7	437	345	862	197	165	57	55
10-8	467	345	892	197	165	58	56
10-9	497	355	932	230	188	65	63
10-10	527	355	962	230	188	66	64
10-11	557	355	992	230	188	67	65
10-12	665	355	1100	230	188	68	66
10-13	695	390	1165	260	208	88	86
10-14	725	390	1195	260	208	89	87
10-15	755	390	1225	260	208	90	88
10-16	785	390	1255	260	208	99	97
10-17	815	390	1285	260	208	100	98
10-18	845	390	1315	260	208	101	99
10-19	875	390	1345	260	208	102	100
10-20	905	390	1375	260	208	103	101
10-21	935	390	1405	260	208	104	102
10-22	995	500	1575	330	255	170	168

МОДЕЛЬ	РАЗМЕРЫ					N.W kg	
	H1	H2	H/H0	D1	D2	CDM	CDMF
20-1	297	245	632	170	142	40	33
20-2	307	290	687	190	155	48	41
20-3	362	345	807	230	188	66	59
20-4	485	390	965	260	208	88	81
20-5	530	390	1010	260	208	90	83
20-6	575	390	1055	260	208	99	92
20-7	620	390	1100	260	208	100	93
20-8	695	500	1285	330	255	167	160
20-10	785	500	1375	330	255	170	163
20-12	875	500	1465	330	255	188	181
20-14	965	500	1555	330	255	191	184
20-17	1100	550	1740	330	255	212	205

РАЗМЕРЫ И ВЕС

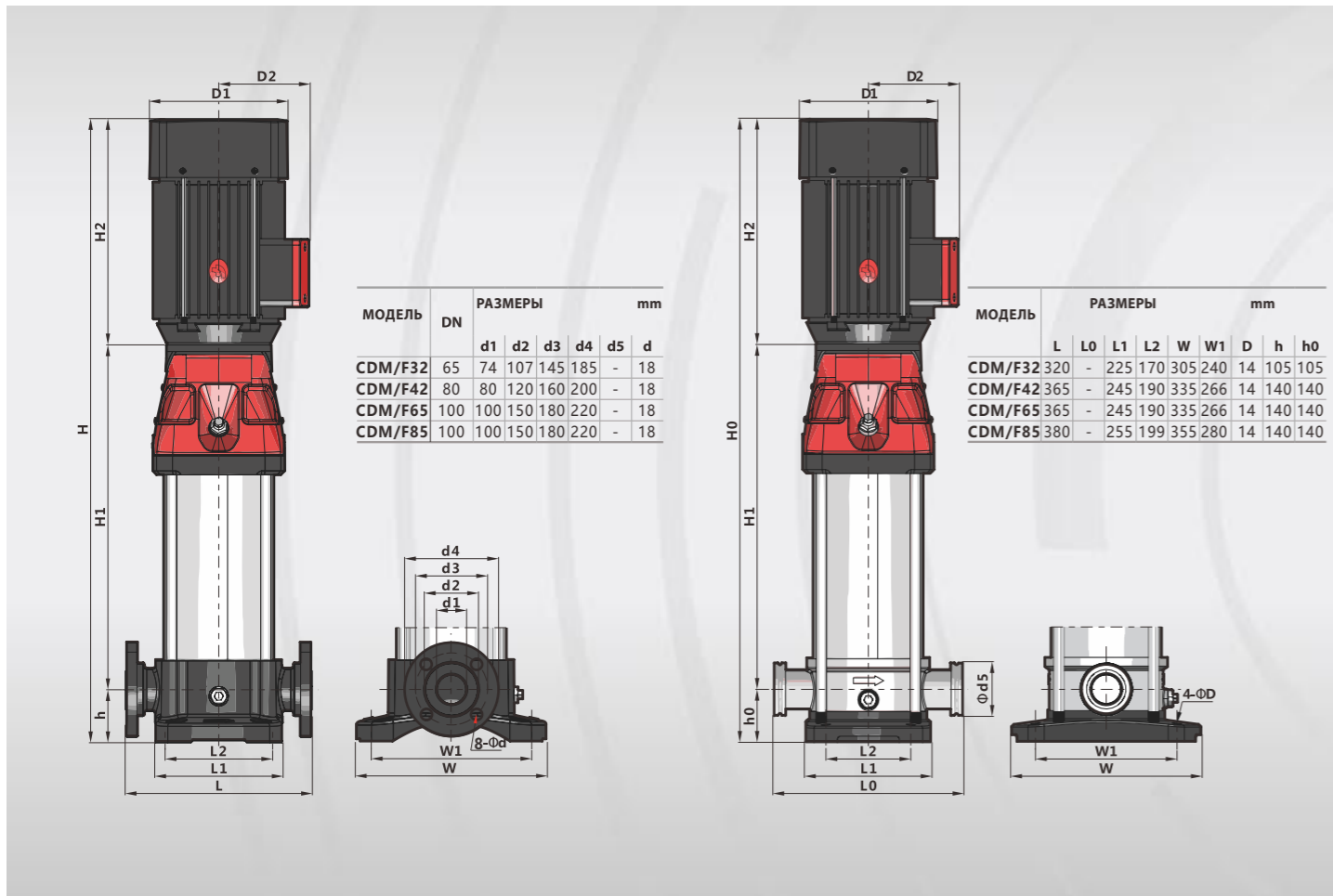

МОДЕЛЬ	H1 mm	H2 mm	H/H0 mm	D1 mm	D2 mm	CDM kg	CDMF kg
CDM32-1-1	329	290	724	190	155	66	54
CDM32-1	329	290	724	190	155	68	56
CDM32-2-2	399	345	849	197	165	73	69
CDM32-2	399	355	859	230	180	79	75
CDM32-3-2	560	390	1055	260	208	102	98
CDM32-3	560	390	1055	260	208	102	98
CDM32-4-2	630	390	1125	260	208	113	109
CDM32-4	630	390	1125	260	208	113	109
CDM32-5-2	730	500	1335	330	255	184	179
CDM32-5	730	500	1335	330	255	184	179
CDM32-6-2	800	500	1405	330	255	186	182
CDM32-6	800	500	1405	330	255	186	182
CDM32-7-2	870	500	1475	330	255	204	200
CDM32-7	870	500	1475	330	255	204	200
CDM32-8-2	940	500	1545	330	255	207	203
CDM32-8	940	500	1545	330	255	207	203

МОДЕЛЬ	H1 mm	H2 mm	H/H0 mm	D1 mm	D2 mm	CDM kg	CDMF kg
CDM32-9-2	1010	550	1665	330	255	218	214
CDM32-9	1010	550	1665	330	255	218	214
CDM32-10-2	1080	550	1735	330	255	221	217
CDM32-10	1080	550	1735	330	255	221	217
CDM32-11-2	1150	575	1830	360	285	277	272
CDM32-11	1150	575	1830	360	285	277	272
CDM32-12-2	1220	575	1900	360	285	280	275
CDM32-12	1220	575	1900	360	285	280	275
CDM32-13-2	1290	650	2045	400	310	343	339
CDM32-13	1290	650	2045	400	310	343	339
CDM32-14-2	1360	650	2115	400	310	346	342
CDM32-14	1360	650	2115	400	310	346	342
CDM32-15-2	1430	650	2185	400	310	349	345
CDM32-15	1430	650	2185	400	310	349	345
CDM32-16-2	1500	650	2255	400	310	352	347
CDM32-16	1500	650	2255	400	310	352	347

РАЗМЕРЫ И ВЕС

МОДЕЛЬ	H1 mm	H2 mm	H/H0 mm	D1 mm	D2 mm	CDM kg	CDMF kg
CDM42-1-1	350	345	835	197	165	83	73
CDM42-1	350	355	845	230	188	90	80
CDM42-2-2	521	390	1051	260	208	113	103
CDM42-2	521	390	1051	260	208	121	111
CDM42-3-2	631	500	1271	330	255	192	182
CDM42-3	631	500	1271	330	255	192	182
CDM42-4-2	711	500	1351	330	255	211	201
CDM42-4	711	500	1351	330	255	211	201
CDM42-5-2	791	550	1481	330	255	223	212
CDM42-5	791	550	1481	330	255	223	212
CDM42-6-2	871	575	1586	360	285	279	269
CDM42-6	871	575	1586	360	285	279	269
CDM42-7-2	951	650	1741	400	310	343	333
CDM42-7	951	650	1741	400	310	343	333
CDM42-8-2	1031	650	1821	400	310	347	337
CDM42-8	1031	650	1821	400	310	347	337
CDM42-9-2	1111	650	1901	400	310	350	340
CDM42-9	1111	650	1901	400	310	370	360
CDM42-10-2	1191	650	1981	400	310	374	364
CDM42-10	1191	650	1981	400	310	374	364
CDM42-11-2	1271	685	2096	450	345	477	467
CDM42-11	1271	685	2096	450	345	477	467
CDM42-12-2	1351	685	2176	450	345	481	471
CDM42-12	1351	685	2176	450	345	481	471
CDM42-13-2	1431	685	2256	450	345	484	474

МОДЕЛЬ	H1 mm	H2 mm	H/H0 mm	D1 mm	D2 mm	CDM kg	CDMF kg
CDM65-1-1	353	355	848	230	188	101	70
CDM65-1	444	390	974	260	208	121	90
CDM65-2-2	527	390	1057	260	208	133	102
CDM65-2-1	557	500	1197	330	255	201	170
CDM65-2	557	500	1197	330	255	201	170
CDM65-3-2	640	500	1280	330	255	219	188
CDM65-3-1	640	500	1280	330	255	219	188
CDM65-3	640	550	1330	330	255	227	196
CDM65-4-2	723	550	1413	330	255	231	200
CDM65-4-1	723	575	1438	360	285	284	253
CDM65-4	723	575	1438	360	285	284	253
CDM65-5-2	806	650	1596	400	310	349	318
CDM65-5-1	806	650	1596	400	310	349	318
CDM65-5	806	650	1596	400	310	349	318
CDM65-6-2	889	650	1679	400	310	353	322
CDM65-6-1	889	650	1679	400	310	373	342
CDM65-6	889	650	1679	400	310	373	342
CDM65-7-2	972	650	1762	400	310	377	346
CDM65-7-1	972	650	1762	400	310	377	346
CDM65-7	972	685	1797	460	340	477	446
CDM65-8-2	1055	685	1880	460	340	481	450
CDM65-8-1	1055	685	1880	460	340	481	450
CDM85-1-1	453	390	983	260	208	110	101
CDM85-1	453	390	983	260	208	118	109
CDM85-2-2	575	500	1215	330	255	190	181
CDM85-2	575	500	1215	330	255	205	196
CDM85-3-2	667	550	1357	330	255	217	208
CDM85-3	667	575	1382	360	285	270	261
CDM85-4-2	759	650	1549	400	310	335	326
CDM85-4	759	650	1549	400	310	335	326
CDM85-5-2	851	650	1641	400	310	359	350
CDM85-5	851	650	1641	400	310	359	350
CDM85-6-2	943	685	1768	460	340	463	454
CDM85-6	943	685	1768	460	340	463	454